

EPOS4

Positioning Controllers

Firmware Specification



epos.maxonmotor.com

Document ID: rel8234

TABLE OF CONTENTS

1 About 7

1.1 About this Document 7

1.2 About the Devices 10

1.3 About the Safety Precautions 10

2 System Overview 11

2.1 Device Architecture 11

2.2 Device Control 13

2.3 System Units 16

2.4 USB Bus Powering 17

3 Operating Modes 19

3.1 Operating Mode Selection Guide 19

3.2 Overview 20

3.3 Profile Position Mode (PPM) 21

3.4 Profile Velocity Mode (PVM) 25

3.5 Homing Mode (HMM) 28

3.6 Cyclic Synchronous Position Mode (CSP) 37

3.7 Cyclic Synchronous Velocity Mode (CSV) 41

3.8 Cyclic Synchronous Torque Mode (CST) 44

3.9 Position Control Function 47

3.10 Velocity Control Function 49

3.11 Current Control Function 51

READ THIS FIRST

These instructions are intended for qualified technical personnel. Prior commencing with any activities...

- you must carefully read and understand this manual and
- you must follow the instructions given therein.

EPOS4 positioning controllers are considered as partly completed machinery according to EU Directive 2006/42/EC, Article 2, Clause (g) and **are intended to be incorporated into or assembled with other machinery or other partly completed machinery or equipment.**

Therefore, you must not put the device into service,...

- unless you have made completely sure that the other machinery fully complies with the EU directive's requirements!
- unless the other machinery fulfills all relevant health and safety aspects!
- unless all respective interfaces have been established and fulfill the herein stated requirements!

4	Inputs and Outputs	55
4.1	Digital Inputs	55
4.2	Digital Outputs	56
4.3	Analog Inputs	56
4.4	Analog Outputs	57
5	Communication	59
5.1	USB & RS232 Communication	59
5.2	CAN Communication	59
5.3	EtherCAT Communication	59
5.4	Gateway Communication (USB/RS232 to CAN)	60
6	Object Dictionary	61
6.1	Overview	61
6.1.1	Object Data Types	61
6.1.2	Object Codes	61
6.1.3	Object Access Types	61
6.1.4	Object Flags	62
6.1.5	Entries Overview	62
6.2	Objects.	66
6.2.1	Device type	66
6.2.2	Error register	66
6.2.3	Error history.	67
6.2.4	COB-ID SYNC.	68
6.2.5	Store parameters	69
6.2.6	Restore default parameters.	70
6.2.7	COB-ID EMCY	71
6.2.8	Consumer heartbeat time	72
6.2.9	Producer heartbeat time	73
6.2.10	Identity object	73
6.2.11	Diagnosis history.	75
6.2.12	SDO server parameter	78
6.2.13	Receive PDO 1 parameter	79
6.2.14	Receive PDO 2 parameter	81
6.2.15	Receive PDO 3 parameter	82
6.2.16	Receive PDO 4 parameter	83
6.2.17	Receive PDO 1 mapping.	84
6.2.18	Receive PDO 2 mapping.	86
6.2.19	Receive PDO 3 mapping.	88
6.2.20	Receive PDO 4 mapping.	90
6.2.21	Transmit PDO 1 parameter	92
6.2.22	Transmit PDO 2 parameter	94
6.2.23	Transmit PDO 3 parameter	96
6.2.24	Transmit PDO 4 parameter	98
6.2.25	Transmit PDO 1 mapping	100
6.2.26	Transmit PDO 2 mapping	102
6.2.27	Transmit PDO 3 mapping	104

6.2.28	Transmit PDO 4 mapping	106
6.2.29	SYNC manager communication type	108
6.2.30	SYNC manager 2 PDO assignment	110
6.2.31	SYNC manager 3 PDO assignment	111
6.2.32	SYNC manager 2 parameter	112
6.2.33	SYNC manager 3 parameter	115
6.2.34	Program data	118
6.2.35	Program control	119
6.2.36	Program software identification	120
6.2.37	Flash status identification	121
6.2.38	Node-ID	123
6.2.39	CAN bit rate	124
6.2.40	RS232 bit rate	125
6.2.41	RS232 frame timeout	125
6.2.42	USB frame timeout	126
6.2.43	CAN bit rate display	126
6.2.44	Active fieldbus	127
6.2.45	Additional identity	127
6.2.46	Extension 1 identity	128
6.2.47	Custom persistent memory	130
6.2.48	Power supply	131
6.2.49	Axis configuration	132
6.2.50	Motor data	145
6.2.51	Electrical system parameters	148
6.2.52	Gear configuration	149
6.2.53	Digital incremental encoder 1	151
6.2.54	Analog incremental encoder	153
6.2.55	SSI absolute encoder	155
6.2.56	Digital Hall sensor	161
6.2.57	Digital incremental encoder 2	162
6.2.58	Current control parameter set	164
6.2.59	Position control parameter set	165
6.2.60	Velocity control parameter set	167
6.2.61	Velocity observer parameter set	169
6.2.62	Dual loop position control parameter set	171
6.2.63	Home position	177
6.2.64	Home offset move distance	178
6.2.65	Current threshold for homing mode	178
6.2.66	Current demand value	178
6.2.67	Current actual values	179
6.2.68	Torque actual values	180
6.2.69	Velocity actual values	181
6.2.70	Standstill window configuration	182
6.2.71	Digital input properties	184
6.2.72	Configuration of digital inputs	185
6.2.73	Digital output properties	187
6.2.74	Configuration of digital outputs	188
6.2.75	Holding brake parameters	189

6.2.76	Analog input properties	191
6.2.77	Analog input adjustment	192
6.2.78	Analog output properties	193
6.2.79	Configuration of analog outputs	194
6.2.80	Analog output general purpose	195
6.2.81	Motor protection	196
6.2.82	Thermal controller protection	197
6.2.83	Abort connection option code	197
6.2.84	Error code	198
6.2.85	Controlword	199
6.2.86	Statusword	200
6.2.87	Quick stop option code	201
6.2.88	Shutdown option code	201
6.2.89	Disable operation option code	202
6.2.90	Fault reaction option code	202
6.2.91	Modes of operation	203
6.2.92	Modes of operation display	203
6.2.93	Position demand value	204
6.2.94	Position actual value	204
6.2.95	Following error window	204
6.2.96	Following error timeout	205
6.2.97	Velocity demand value	205
6.2.98	Velocity actual value	205
6.2.99	Target torque	206
6.2.100	Motor rated torque	206
6.2.101	Torque actual value	206
6.2.102	Target position	207
6.2.103	Position range limit	208
6.2.104	Software position limit	209
6.2.105	Max profile velocity	210
6.2.106	Max motor speed	210
6.2.107	Profile velocity	211
6.2.108	Profile acceleration	211
6.2.109	Profile deceleration	211
6.2.110	Quick stop deceleration	212
6.2.111	Motion profile type	212
6.2.112	Homing method	213
6.2.113	Homing speeds	214
6.2.114	Homing acceleration	215
6.2.115	SI unit position	215
6.2.116	SI unit velocity	216
6.2.117	SI unit acceleration	217
6.2.118	Position offset	217
6.2.119	Velocity offset	218
6.2.120	Torque offset	218
6.2.121	Interpolation time period	219
6.2.122	Max acceleration	220
6.2.123	Additional position actual values	221

6.2.124	Additional velocity actual values	222
6.2.125	Following error actual value	224
6.2.126	Digital inputs	225
6.2.127	Digital outputs	226
6.2.128	Target velocity	227
6.2.129	Motor type	227
6.2.130	Supported drive modes	228
6.2.131	Modular device profile	229
6.2.132	Configured module ident list	230
6.2.133	Detected module ident list	232
6.3	Modular Device Profile Module	233
6.3.1	MDP Module PPM	233
6.3.2	MDP Module PVM	233
6.3.3	MDP Module CSP	234
6.3.4	MDP Module CSV	234
6.3.5	MDP Module CST	235
7	Error Handling	237
7.1	Emergency Message Frame	237
7.2	Device Errors	237
7.3	CANopen Communication Errors (Abort Codes)	254
7.4	EtherCAT FoE Error Codes	255
8	Firmware Version History	257
8.1	Version Overview	257
8.2	EPOS4_0150h_xxxxh_0000h_0000h_0000h (Release 2018-12)	258
8.3	EPOS4_0140h_xxxxh_0000h_0000h_0000h (Release 2018-06)	259
8.4	EPOS4_0130h_xxxxh_0000h_0000h_0000h (Release 2017-12)	261
8.5	EPOS4_0120h_xxxxh_0000h_0000h_0000h (Release 2017-06)	262
8.6	EPOS4_0110h_xxxxh_0000h_0000h_0000h (Release 2016-11)	263
8.7	EPOS4_0100h_xxxxh_0000h_0000h_0000h (Release 2016-06)	264

1 About

1.1 About this Document

1.1.1 Intended Purpose

The purpose of the present document is to familiarize you with the described equipment and the tasks on safe and adequate installation and/or commissioning. Follow the described instructions ...

- to avoid dangerous situations,
- to keep installation and/or commissioning time at a minimum,
- to increase reliability and service life of the described equipment.

The present document is part of a documentation set and provides EPOS4 firmware details and contains descriptions on architecture, device states, operation modes, error handling, and object dictionary. The below overview shows the documentation hierarchy and the interrelationship of its individual parts:

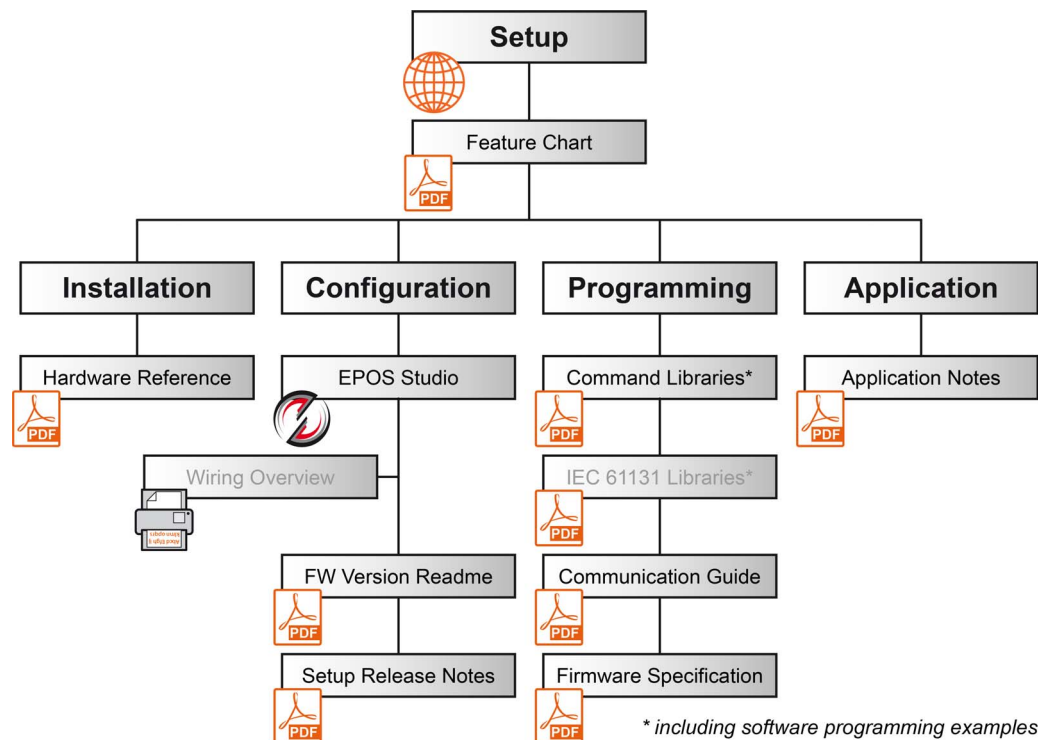

Figure 1-1 Documentation structure

Find the latest edition of the present document as well as additional documentation and software for EPOS4 positioning controllers also on the Internet: → <http://epos.maxonmotor.com>

1.1.2 Target Audience

This document is meant for trained and skilled personnel working with the equipment described. It conveys information on how to understand and fulfill the respective work and duties.

This document is a reference book. It does require particular knowledge and expertise specific to the equipment described.

1.1.3 How to use

Take note of the following notations and codes which will be used throughout the document.

Notation	Explanation
EPOS	stands for all supported positioning controller types of the EPOS family (EPOS, EPOS2, and EPOS4)
EPOS2	stands for "EPOS2 positioning controller"
EPOS4	stands for "EPOS4 positioning controller"
«Abcd»	indicating a title or a name (such as of document, product, mode, etc.)
(n)	referring to an item (such as order number, list item, etc.)
*	referring to an internal value
→	denotes "see", "see also", "take note of", or "go to"

Table 1-1 Notations used

In the later course of the present document, the following abbreviations and acronyms will be used:

Short	Description
CCW	Counterclockwise
CiA	CAN in Automation
CSP	Cyclic Synchronous Position Mode
CST	Cyclic Synchronous Torque Mode
CSV	Cyclic Synchronous Velocity Mode
CW	Clockwise
EDS	Electronic Data Sheet
GPIO	General purpose input/output
HMM	Homing Mode
NMT	Network Management
OBD	Object Dictionary
PDO	Process Data Object
PPM	Profile Position Mode
PVM	Profile Velocity Mode
SDO	Service Data Object

Table 1-2 Abbreviations & acronyms used

1.1.4 Symbols and Signs



Requirement / Note / Remark

Indicates an action you must perform prior continuing or refers to information on a particular item.



Best Practice

Gives advice on the easiest and best way to proceed.



Material Damage

Points out information particular to potential damage of equipment.

1.1.5 Trademarks and Brand Names

For easier legibility, registered brand names are listed below and will not be further tagged with their respective trademark. It must be understood that the brands (the below list is not necessarily concluding) are protected by copyright and/or other intellectual property rights even if their legal trademarks are omitted in the later course of this document.

Brand name	Trademark owner
Adobe® Reader®	© Adobe Systems Incorporated, USA-San Jose, CA
BiSS	© iC-Haus GmbH, DE-Bodenheim
CANopen® CiA®	© CiA CAN in Automation e.V, DE-Nuremberg
EnDat	© DR. JOHANNES HEIDENHAIN GmbH, DE-Traunreut
EtherCAT®	© EtherCAT Technology Group, DE-Nuremberg, licensed by Beckhoff Automation GmbH, DE-Verl

Table 1-3 Brand names and trademark owners

1.1.6 Sources for additional Information

For further details and additional information, please refer to below listed sources:

#	Reference
[1]	USB Implementers Forum: Universal Serial Bus Revision 2.0 Specification www.usb.org/developers/docs
[2]	CiA 301 CANopen application layer and communication profile www.can-cia.org
[3]	CiA 306 CANopen electronic data sheet specification www.can-cia.org
[4]	CiA 402 CANopen device profile for drives and motion control www.can-cia.org
[5]	Bosch's CAN Specification 2.0 www.can-cia.org
[6]	Konrad Etschberger: Controller Area Network ISBN 3-446-21776-2
[7]	maxon motor: EPOS4 Communication Guide www.maxonmotor.com
[8]	maxon motor: EPOS4 Application Notes www.maxonmotor.com

Continued on next page.

#	Reference
[9]	IEC 61158-x-12: Industrial communication networks – Fieldbus specifications (CPF 12)
[10]	IEC 61800-7: Adjustable speed electrical power drives systems (Profile type 1)
[11]	ETG.1000 EtherCAT Specification www.ethercat.org
[12]	ETG.1020 EtherCAT Protocol Enhancements Specification www.ethercat.org
[13]	ETG.2000 EtherCAT Slave Information (ESI) Specification www.ethercat.org
[14]	EN 5325-4 Industrial communications subsystem based on ISO 11898 (CAN) for controller device interfaces Part4: CANopen

Table 1-4 Sources for additional information

1.1.7 Copyright

© 2018 maxon motor. All rights reserved.

The present document – including all parts thereof – is protected by copyright. Any use (including reproduction, translation, microfilming, and other means of electronic data processing) beyond the narrow restrictions of the copyright law without the prior approval of maxon motor ag, is not permitted and subject to prosecution under the applicable law.

maxon motor ag
Brünigstrasse 220
P.O.Box 263
CH-6072 Sachseln

Phone +41 41 666 15 00
Fax +41 41 666 16 50
Web www.maxonmotor.com

1.2 About the Devices

maxon motor control's EPOS4 positioning controllers are small-sized, full digital, smart positioning control units. Their high power density allow flexible use for brushed DC and brushless EC (BLDC) motors with various feedback options, such as Hall sensors, incremental encoders as well as absolute sensors in a multitude of drive applications.

1.3 About the Safety Precautions

IMPORTANT NOTICE: PREREQUISITES FOR PERMISSION TO COMMENCE INSTALLATION

EPOS4 positioning controllers are considered as partly completed machinery according to EU Directive 2006/42/EC, Article 2, Clause (g) and **are intended to be incorporated into or assembled with other machinery or other partly completed machinery or equipment.**



WARNING

Risk of Injury

Operating the device without the full compliance of the surrounding system with the EU directive 2006/42/EC may cause serious injuries!

- Do not operate the device, unless you have made sure that the other machinery fulfills the requirements stated in EU directive!
- Do not operate the device, unless the surrounding system fulfills all relevant health and safety aspects!
- Do not operate the device, unless all respective interfaces have been established and fulfill the stated requirements!

2 System Overview

2.1 Device Architecture

The EPOS4's communication interface follows these specifications (numbers in brackets refer to respective items listed on →page 1-9):

- CiA 301 V4.2; CANopen application layer and communication profile (→[2]), corresponds with the international standard EN 5325-4; Industrial communications subsystem based on ISO 11898 (CAN) (→[14])
- CiA 306 V1.3; CANopen electronic data sheet specification (→[3])
- CiA 402 V4.0; CANopen device profile for drives and motion control (→[4]), corresponds with international standard IEC 61800-7 Ed 2.0; Generic interface and use of profiles for power drive systems – profile type 1 (→[10])
- ETG.1000 V1.0.4; EtherCAT Specification (→[11]), corresponds with the international standard IEC 61158-x-12; Industrial communication networks – Fieldbus specifications (CPF 12: EtherCAT) (→[9])
- ETG.1020 V1.2.0; EtherCAT Protocol Enhancements Specification (→[12])
- ETG.2000 V1.0.9; EtherCAT Slave Information (ESI) Specification (→[13])

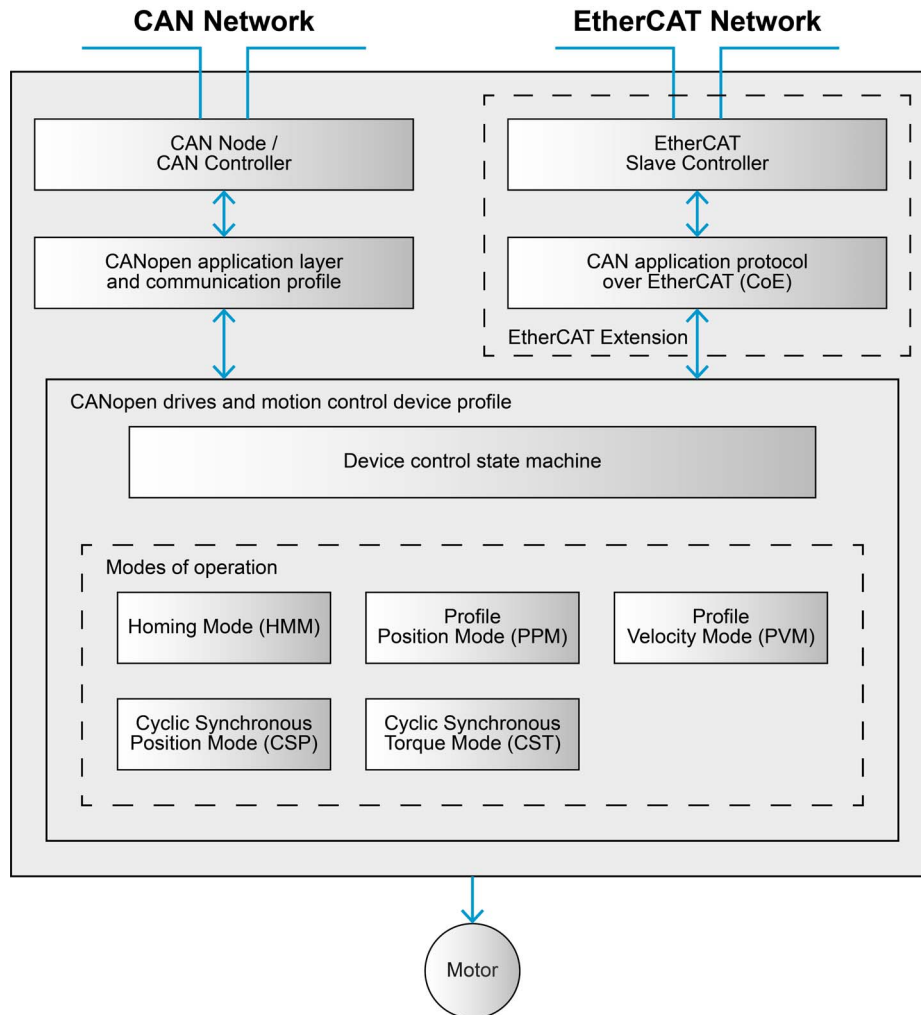

Figure 2-2 Communication architecture

DEVICE CONTROL

Starting and stopping of the drive and several mode-specific commands are executed by the state machine.

MODES OF OPERATION

The operating mode defines the behavior of the drive.

2.2 Device Control

The state machine describes the axis state and the possible control sequence of the axis. An axis state represents a special internal or external behavior. The state of the axis also determines the commands that will be accepted.

States may be changed using the →Controlword and/or according to internal events. The actual state can be read using the →Statusword. A new state transition must not be initiated before the previous one is completed and the →Statusword is changed accordingly.

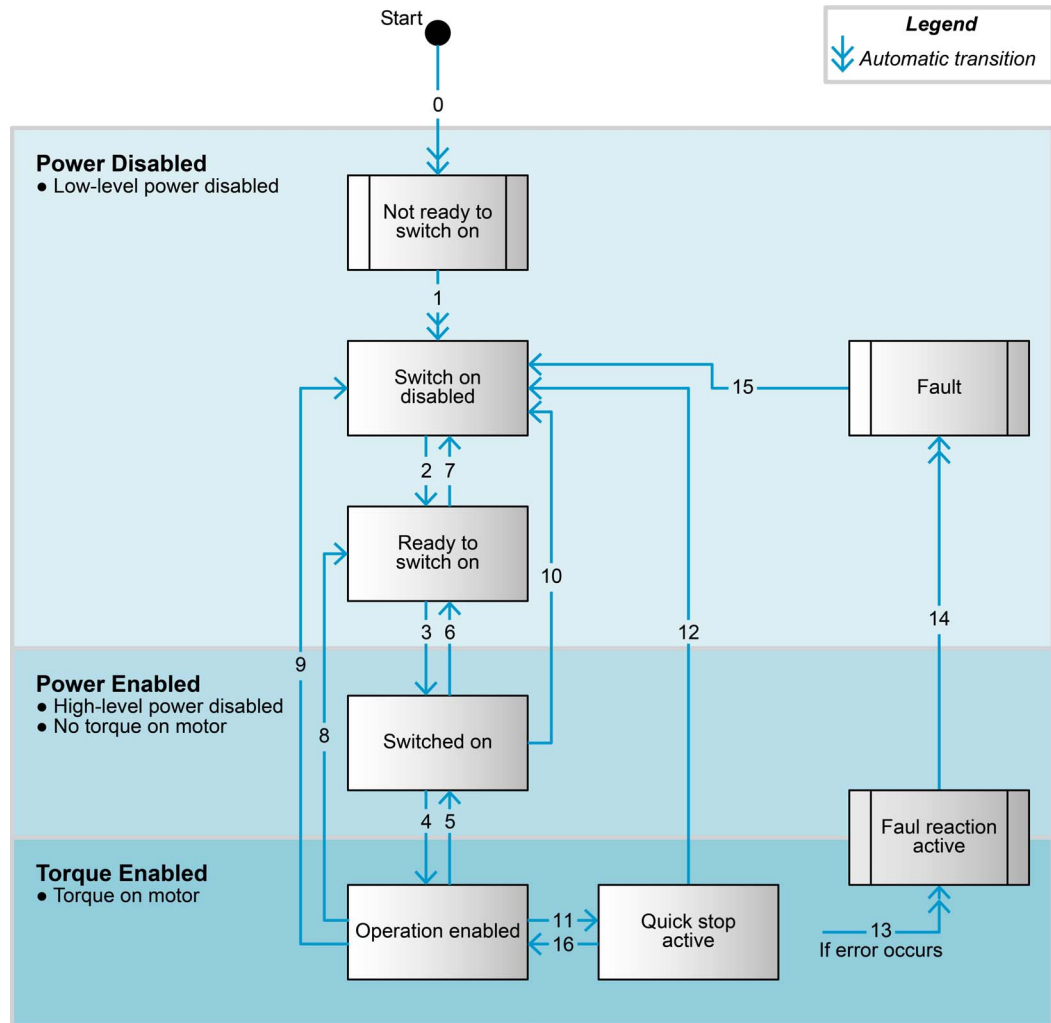

Figure 2-3 Device State Machine

2.2.1 State of the Drive

The following → Statusword bits indicate the actual state of the drive.

State	Statusword [binary]	Description
Not ready to switch on	xxxx xxxx x00x 0000	Drive function is disabled
Switch on disabled	xxxx xxxx x10x 0000	Drive initialization is complete. Drive parameters may be changed. Drive function is disabled.
Ready to switch on	xxxx xxxx x01x 0001	Drive parameters may be changed. Drive function is disabled.
Switched on	xxxx xxxx x01x 0011	Drive function is disabled. Current offset calibration done.
Operation enabled	xxxx xxxx x01x 0111	No faults have been detected. Drive function is enabled and power is applied to the motor.
Quick stop active	xxxx xxxx x00x 0111	«Quick stop» function is being executed. Drive function is enabled and power is applied to the motor.
Fault reaction active	xxxx xxxx x00x 1111	A fault has occurred in the drive. Selected fault reaction is being executed.
Fault	xxxx xxxx x00x 1000	A fault has occurred in the drive. Drive parameters may have changed. Drive function is disabled.

Table 2-5 Device state bits

2.2.2 State Transitions

State transitions are caused by internal events in the drive or by commands from the host via the → Controlword.



State transition during change of state

If a command is received which causes a change of state, this command will be processed completely and the new state attained before the next command can be processed.

Transition	Event	Action
0	Reset	Initialize drive
1	Drive has initialized successfully	Activate communication
2	«Shutdown» command received	
3	«Switched on» command received	Initialize current sensor. Current offset calibration.
4	«Enable operation» command received	Enable drive function (enable current controller and, if needed, position or velocity controller)
5	«Disable operation» command received	Stop movement according to «Disable operation option code». Disable drive function.
6	«Shutdown» command received	Disable power section
7	«Quick stop» or «Disable voltage» command received	
8	«Shutdown» command received	Stop movement according to «Shutdown option code». Disable drive function and power section.

Continued on next page.

Transition	Event	Action
9	«Disable voltage» command received	Stop movement according to «Shutdown option code». Disable drive function and power section.
10	«Quick stop» or «Disable voltage» command received	
11	«Quick stop» command received	Stop movement according to «Quick stop option code»
12	«Disable voltage» command received	Disable drive function and power section
13	A fault has occurred	Start fault reaction
14	The fault reaction is completed	Disable drive function and power section
15	«Fault reset» command received	Reset fault condition if no fault is present
16	«Enable operation» command received	

Table 2-6 Device state transitions

2.2.3 Device Control Commands

Axis control commands are triggered by the following bit patterns in the →Controlword.

Command	Controlword LowByte [binary]	State transition
Shutdown	0xxx x110	2, 6, 8
Switch on	0xxx x111	3
Switch on & Enable operation	0xxx 1111	3, 4 (*1)
Disable voltage	0xxx xx0x	7, 9, 10, 12
Quick stop	0xxx x01x	11
Disable operation	0xxx 0111	5
Enable operation	0xxx 1111	4, 16
Fault reset	0xxx xxxx → 1xxx xxxx	14, 15

(*1) Automatic transition to state «Operation enabled» after execution of command «Switch on»

Table 2-7 Axis control commands

2.3 System Units

The user-defined units for this device are as follows:

- Position Units (→“SI unit position” on page 6-215)
- Velocity Units (→“SI unit velocity” on page 6-216)
- Acceleration Units (→“SI unit acceleration” on page 6-217)

The units are used for all objects that support user-defined units. They are specified by the SI unit objects. Objects with factor group-independent values have fixed units specified by the object.

Coding of user-defined units and prefixes takes place as to →Table 2-8.

Bit 31...24	Bit 23...16	Bit 15...8	Bit 7...0
Prefix	Numerator	Denominator	reserved (0)

Table 2-8 User-defined units – Parameter structure

2.3.1 SI Units

Description	Name	Symbol	Notation index
Dimensionless	–	–	0x00
<i>Length</i>	<i>Meter</i>	<i>m</i>	<i>0x01</i>
<i>Mass</i>	<i>Kilogram</i>	<i>kg</i>	<i>0x02</i>
Time	Second	s	0x03
<i>Electric current</i>	<i>Ampere</i>	<i>A</i>	<i>0x04</i>
Time	Minute	min	0x47
<i>Square second</i>	<i>Square second</i>	<i>s²</i>	<i>0x57</i>

Table 2-9 SI units – Notation index

2.3.2 CiA 402 Application Profile-specific Units

Description	Name	Symbol	Notation index
Revolutions	revolutions	rev	0xB4
Increments	increments	inc	0xB5
<i>Steps</i>	<i>steps</i>	<i>steps</i>	<i>0xAC</i>

Table 2-10 CiA 402 Application profile-specific units – Notation index

2.3.3 Unit Prefixes

Prefix	Factor	Symbol	Notation index
<i>Mega</i>	10^6	<i>M</i>	0x06
<i>Kilo</i>	10^3	<i>k</i>	0x03
<i>Hecta</i>	10^2	<i>h</i>	0x02
<i>Deca</i>	10^1	<i>da</i>	0x01
–	10^0	–	0x00
Deci	10^{-1}	<i>d</i>	0xFF
Centi	10^{-2}	<i>c</i>	0xFE
Milli	10^{-3}	<i>m</i>	0xFD
—	10^{-4}	—	0xFC
—	10^{-5}	—	0xFB
Micro	10^{-6}	μ	0xFA

Table 2-11 Unit prefixes – Notation index

2.4 USB Bus Powering

Powering the controller for configuration via USB only is not possible. To use a communication interface, either the power supply or the logic supply must be connected.

••page intentionally left blank••

3 Operating Modes

3.1 Operating Mode Selection Guide

The device behavior depends on the currently activated mode of operation.

- Choose desired mode (→“Overview” on page 3-20).
- Select mode using (→“Modes of operation” on page 6-203).
- Read currently active mode from →“Modes of operation display” on page 6-203.

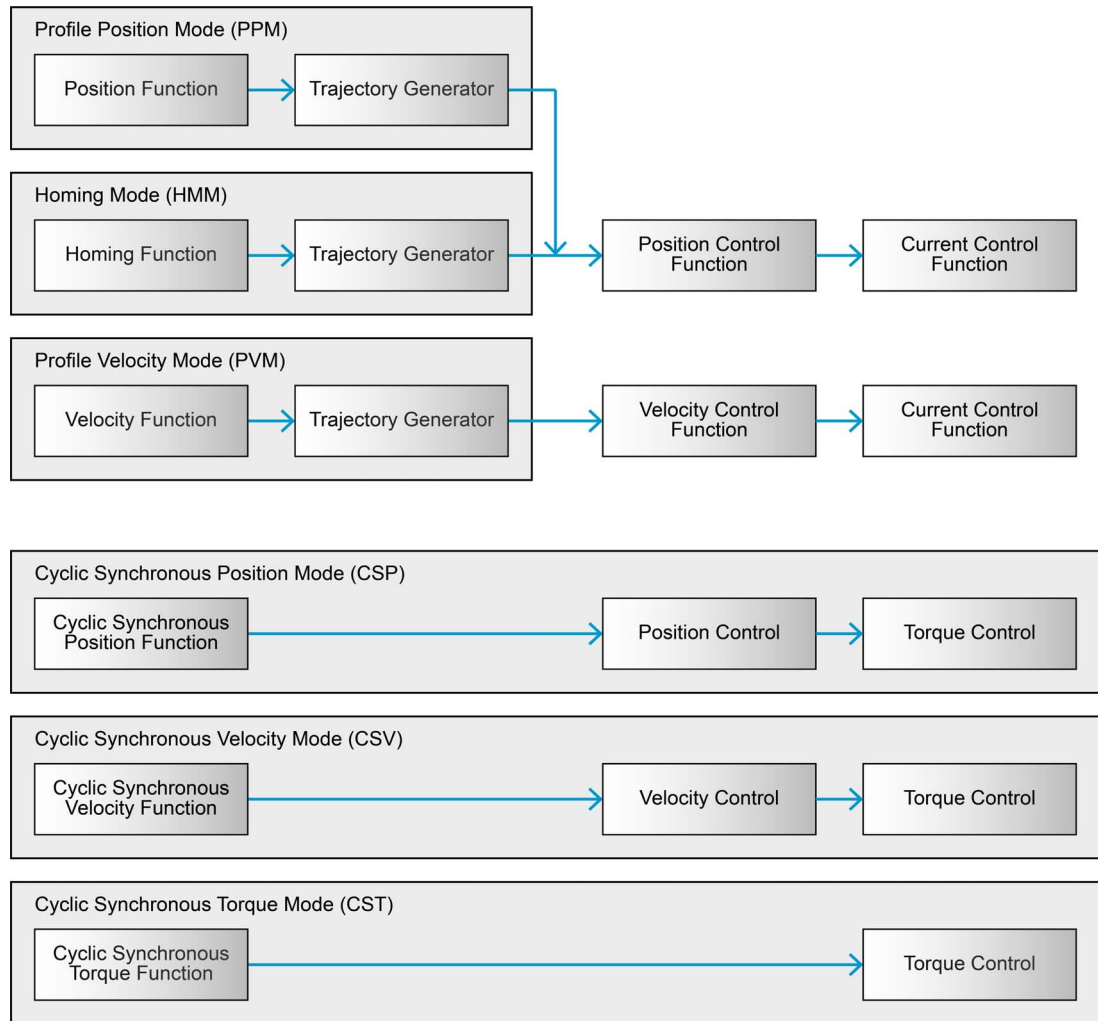

Figure 3-4 Functional architecture

3.2 Overview

PROFILE POSITION MODE (PPM)

Defines the drive's positioning. Speed, position, and acceleration can be limited, profiled moves can be executed using a Trajectory Generator.

For details →page 3-21.

PROFILE VELOCITY MODE (PVM)

Controls the drive's velocity without particular focus on the position. It supplies limit functions and Trajectory Generation.

For details →page 3-25.

HOMING MODE (HMM)

Provides various methods to find the home position (also called reference point or zero point).

For details →page 3-28.

CYCLIC SYNCHRONOUS POSITION MODE (CSP)

The trajectory generator is located in the control device (not in the drive device). In cyclic synchronous manner, it provides a target position to the drive device, which then performs position control, velocity control, and torque control.

For details →page 3-37

CYCLIC SYNCHRONOUS VELOCITY MODE (CSV)

The trajectory generator is located in the control device (not in the drive device). In cyclic synchronous manner, it provides a target velocity to the drive device, which then performs velocity control and torque control.

For details →page 3-41

CYCLIC SYNCHRONOUS TORQUE MODE (CST)

The trajectory generator is located in the control device (not in the drive device). In cyclic synchronous manner, it provides a target torque to the drive device, which then performs torque control.

For details →page 3-44.

3.3 Profile Position Mode (PPM)

A target position is applied to the trajectory generator. It will generate a position demand value for the position control function.



Annotation

Items marked with an asterisk (*) refer to internal values.

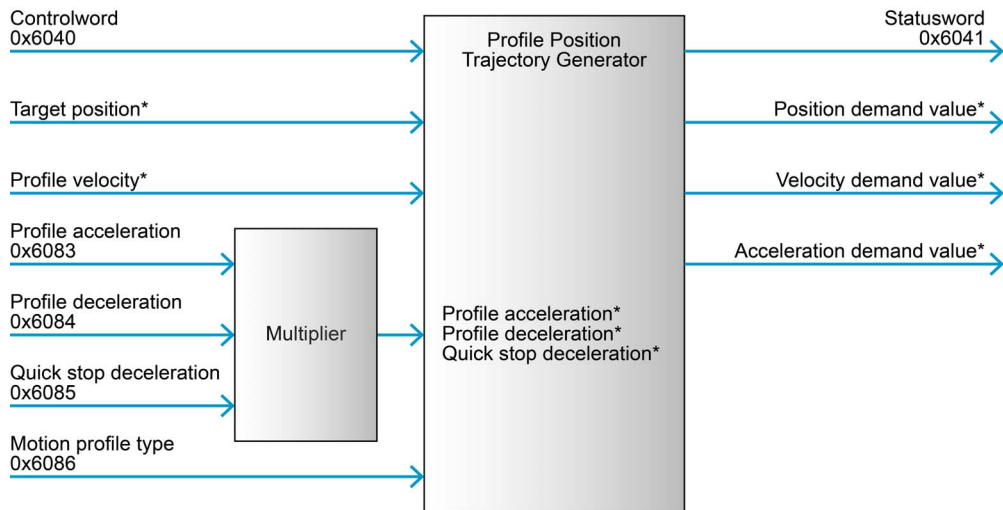
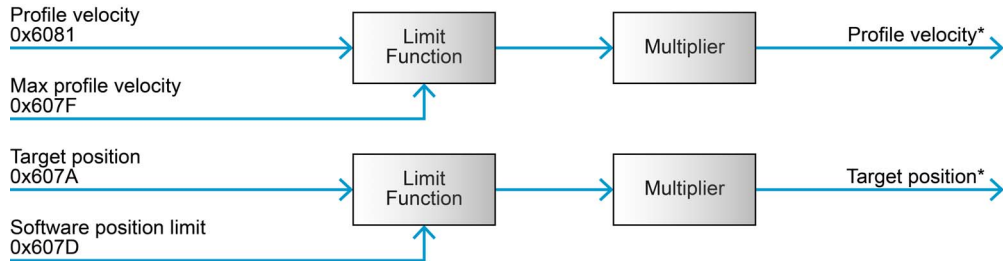

Figure 3-5 Profile Position Mode – Block diagram

3.3.1 Profile Position Trajectory Generator

The trajectory generator supports the following motion profiles.

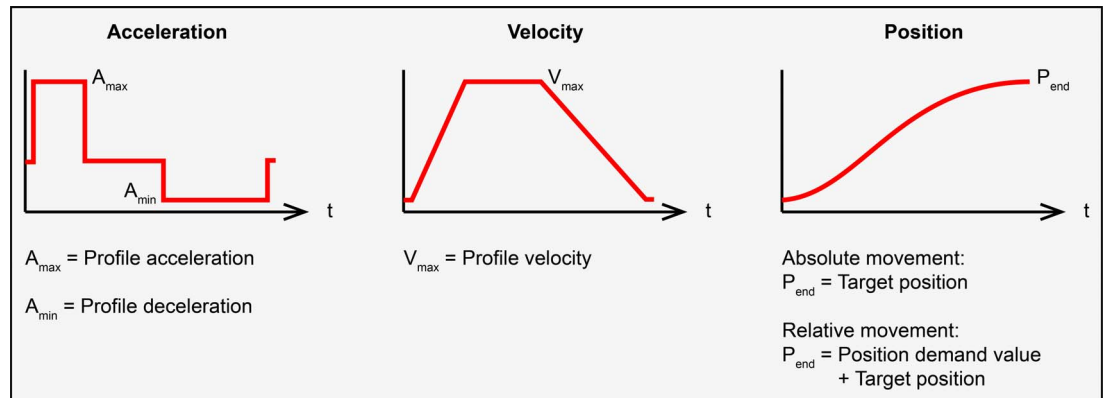

Figure 3-6 Profile position trajectory

3.3.2 How to use «PPM»

CONFIGURATION PARAMETERS

Parameter	Index	Description
→ Software position limit	0x607D	Contains the sub-parameters “Min position limit” and “Max position limit” that define the absolute position limits of the position demand value and position actual value. A new target position will be checked against these limits.
→ Max profile velocity	0x607F	Defines the maximal permitted speed
→ Max motor speed	0x6080	Indicates the configured maximal permitted speed for the motor. It serves as protection of the motor and is taken from the motor data sheet.
→ Max gear input speed	0x3003	Indicates the configured maximal permitted input speed of the gear. It serves as protection of the gear and is taken from the gear data sheet. Together with “Max motor speed”, it limits the speed of the system.
→ Quick stop deceleration	0x6085	Defines the deceleration ramp during a «Quick stop»
→ Max acceleration	0x60C5	Defines the maximal allowed acceleration and deceleration

Table 3-12 Profile Position Mode – Configuration parameters

COMMANDING PARAMETERS

Parameter	Index	Description
→ Controlword	0x6040	The mode will be controlled by a write access to the controlword's mode-dependent bits
→ Target position	0x607A	The position to which the drive is supposed to move using the motion control parameters, such as velocity, acceleration, motion profile type, etc. It will be interpreted as absolute or relative depending on the controlword “abs / rel” flag.
→ Profile velocity	0x6081	The velocity normally attained at the end of the acceleration ramp during a profiled move
→ Profile acceleration	0x6083	Defines the acceleration ramp during a movement
→ Profile deceleration	0x6084	Defines the deceleration ramp during a movement
→ Motion profile type	0x6086	Selects the type of motion profile used for the movement: 0 = linear ramp (trapezoidal profile)

Table 3-13 Profile Position Mode – Commanding parameters

CONTROLWORD (PROFILE POSITION MODE-SPECIFIC BITS)

To perform system endless movements, the “endless movement” bit can be set. Speed is given by →“Profile velocity” on page 6-211 while direction is given by the sign of →“Target position” on page 6-207.

Bit 15	Bit 14...9	Bit 8	Bit 7	Bit 6	Bit 5	Bit 4	Bit 3...0
Endless movement	→ Table 6-12 6	Halt	→ Table 6-12 6	Abs / rel	Change set immediately	New setpoint	→ Table 6-12 6

Table 3-14 Profile Position Mode – Controlword

Name	Value	Description
New setpoint	0	Does not assume →Target position
	0→1	Assume →Target position
Change set immediately	0	Finish actual positioning, then start next positioning. The actual positioning is considered as completed as soon as the position demand value reaches the target position.
	1	Abort actual positioning and start next positioning
Abs / rel	0	→Target position is an absolute value
	1	→Target position is a relative value
Halt	0	Execute or continue positioning
	1	Stop axis with →Profile deceleration
Endless movement	0	Normal operation mode
	1	System will perform endless movement

Table 3-15 Profile Position Mode – Controlword bits

OUTPUT PARAMETERS

Parameter	Index	Description
→Statusword	0x6041	Mode state can be observed by the statusword bits
→Position demand value	0x6062	The output of the trajectory generator. It is used as input for the position control function.

Table 3-16 Profile Position Mode – Output parameters

STATUSWORD (PROFILE POSITION MODE-SPECIFIC BITS)

Bit 15, 14	Bit 13	Bit 12	Bit 11	Bit 10	Bit 9...0
➔ Table 6-127	Following error	Setpoint acknowledge	➔ Table 6-127	Target reached	➔ Table 6-127

Table 3-17 Profile Position Mode – Statusword

Name	Value	Description
Target reached	0	Halt = 0: ➔Target position not reached Halt = 1: Axis decelerates
	1	Halt = 0: ➔Target position reached Halt = 1: Velocity of axis is "0" (zero)
Setpoint acknowledge	0	Positioning to the previous setpoint is ongoing and a new setpoint may be accepted
	1	The previous setpoint has been assumed and no additional setpoint may be accepted
Following error	0	Not following error
	1	Following error

Table 3-18 Profile Position Mode – Statusword bits

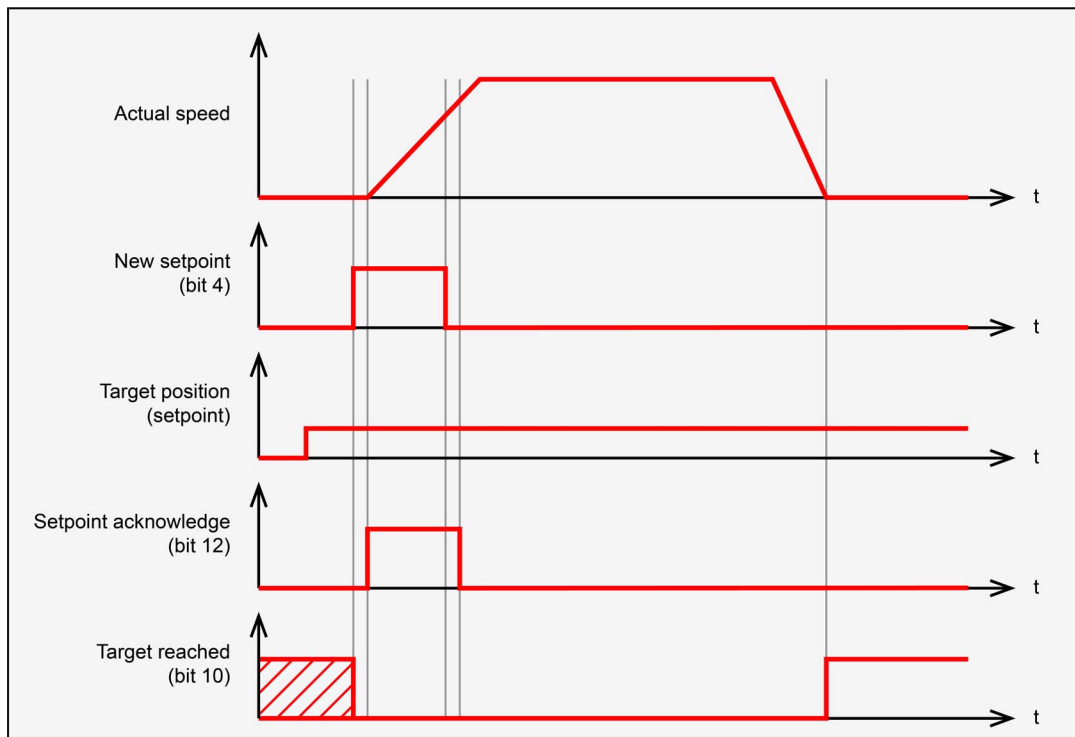

Figure 3-7 Profile Position Mode – Setpoint example

3.4 Profile Velocity Mode (PVM)

The profile velocity mode includes a velocity trajectory generator and a velocity control function.



Annotation

Items marked with an asterisk (*) refer to internal values.

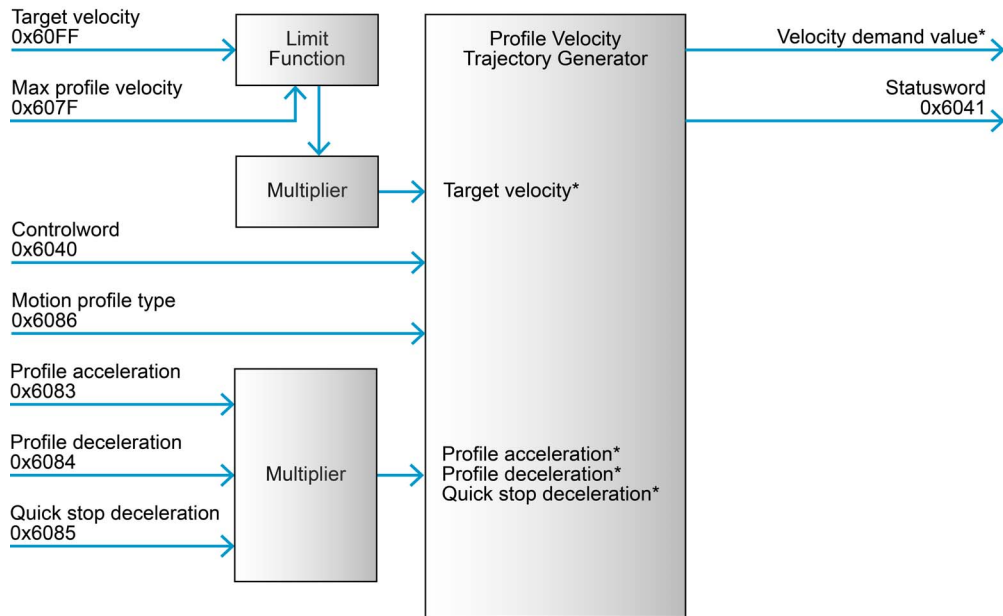

Figure 3-8 Profile Velocity Mode – Block diagram

3.4.1 Profile Velocity Trajectory Generator

The trajectory generator supports the following motion profiles.

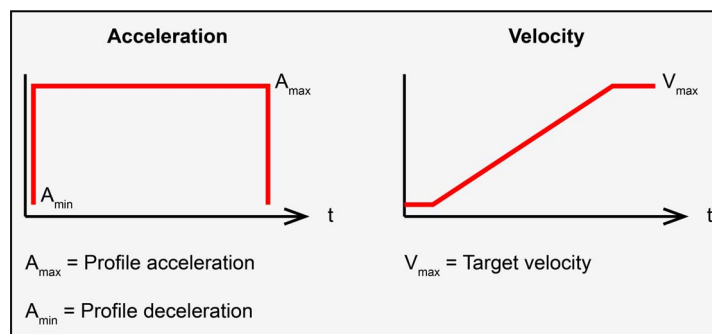

Figure 3-9 Profile velocity trajectory – Linear ramp (trapezoidal profile)

3.4.2 How to use «PVM»

CONFIGURATION PARAMETERS

Parameter	Index	Description
→ Software position limit	0x607D	Contains the sub-parameters “Min position limit” and “Max position limit” that define the absolute position limits of the position demand value and position actual value. A new target position will be checked against these limits.
→ Max profile velocity	0x607F	Defines the maximal permitted speed
→ Max motor speed	0x6080	Indicates the configured maximal permitted speed for the motor. It serves as protection of the motor and is taken from the motor data sheet.
→ Max gear input speed	0x3003	Indicates the configured maximal permitted input speed of the gear. It serves as protection of the gear and is taken from the gear data sheet. Together with “Max motor speed”, it limits the speed of the system.
→ Quick stop deceleration	0x6085	Defines the deceleration ramp during a «Quick stop»
→ Max acceleration	0x60C5	Defines the maximal allowed acceleration and deceleration

Table 3-19 Profile Velocity Mode – Configuration parameters

COMMANDING PARAMETERS

Parameter	Index	Description
→ Controlword	0x6040	The mode will be controlled by a write access to the controlword’s mode-dependent bits. A new target velocity is not assumed before the controlword is written.
→ Target velocity	0x60FF	The speed that the drive is supposed to reach
→ Profile acceleration	0x6083	Defines the acceleration ramp during a movement
→ Profile deceleration	0x6084	Defines the deceleration ramp during a movement
→ Motion profile type	0x6086	Selects the type of motion profile used for the movement: 0 = linear ramp (trapezoidal profile)

Table 3-20 Profile Velocity Mode – Commanding parameters

CONTROLWORD (PROFILE VELOCITY MODE-SPECIFIC BITS)

Bit 15...9	Bit 8	Bit 7	Bit 6...4	Bit 3...0
→ Table 6-126	Halt	→ Table 6-126	reserved	→ Table 6-126

Table 3-21 Profile Velocity Mode – Controlword

Name	Value	Description
Halt	0	Execute or continue motion
	1	Stop axis

Table 3-22 Profile Velocity Mode – Controlword bits

OUTPUT PARAMETERS

Parameter	Index	Description
→ Statusword	0x6041	Mode state can be observed by the statusword bits
→ Velocity demand value	0x606B	The output of the trajectory generator. It is used as input for the velocity control function.

Table 3-23 Profile Velocity Mode – Output parameters

STATUSWORD (PROFILE VELOCITY MODE-SPECIFIC BITS)

Bit 15, 14	Bit 13	Bit 12	Bit 11 (*2)	Bit 10	Bit 9...0
→ Table 6-127	Not used	Speed	Speed is limited	Target reached	→ Table 6-127

(*2) Bit 11 is shared with I2t current limitation feature

Table 3-24 Profile Velocity Mode – Statusword

Name	Value	Description
Target reached	0	Halt = 0: Target velocity not (yet) reached Halt = 1: Axis decelerates
	1	Halt = 0: Target velocity reached Halt = 1: Axis has velocity "0" (zero)
Speed	0	Speed is not equal "0" (zero)
	1	Speed is equal "0" (zero)
Speed is limited	0	Speed is not limited
	1	Speed is limited to → Max profile velocity

Table 3-25 Profile Velocity Mode – Statusword bits

3.5 Homing Mode (HMM)

«Homing» describes the procedure according to which the drive seeks the home position (also called reference point or zero point). There are various methods to achieve this using limit switches at both ends of travel. Some of the methods use the index (zero) pulse train of an incremental encoder.



Annotation

Items marked with an asterisk (*) refer to internal values.

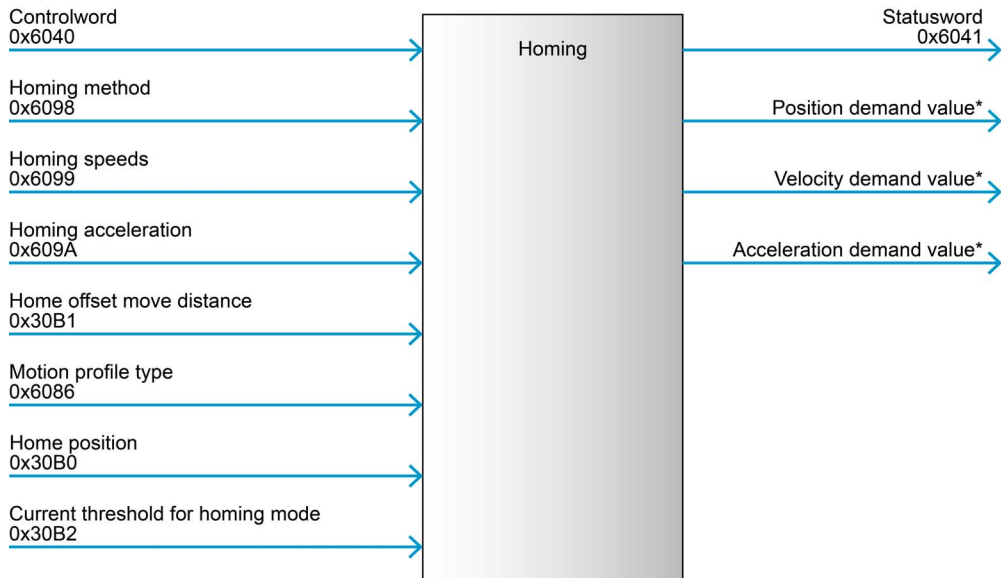

Figure 3-10 Homing Mode – Block diagram

3.5.1 Homing Trajectory Generator

The trajectory generator supports the following motion profiles. The movements are mode-dependent, the end positions will be calculated internally.

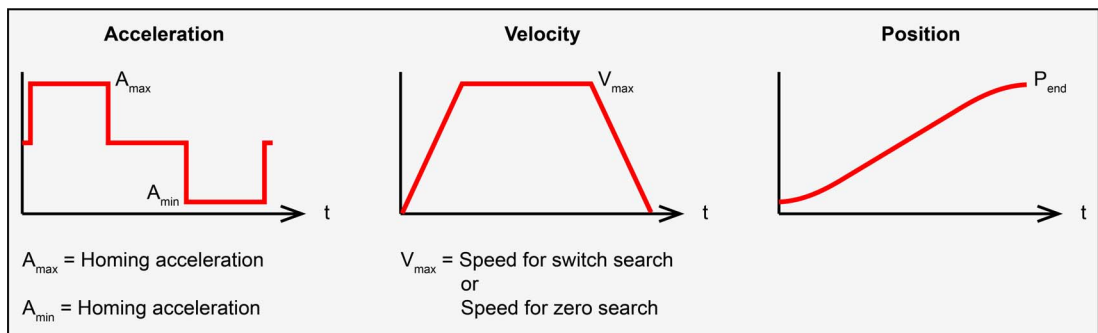

Figure 3-11 Homing trajectory – Linear ramp (trapezoidal profile)

3.5.2 How to use «HMM»

CONFIGURATION PARAMETERS

Parameter	Index	Description
→ Digital input properties	0x3141	Input polarity and logic state
→ Configuration of digital inputs	0x3142	Permits the configuration of digital inputs to digital input functionalities. Necessary for limit and homing switches that are used for «Homing».
→ Digital inputs	0x3141	Input functionality state (after polarity correction)
→ Motion profile type	0x6086	Selects the type of motion profile used for the movement: 0 = linear ramp (trapezoidal profile)

Table 3-26 Homing Mode – Configuration parameters

COMMANDING PARAMETERS

Parameter	Index	Description
→ Controlword	0x6040	The mode will be controlled by a write access to the controlword's mode-dependent bits
→ Homing method	0x6098	Defines the type of homing procedure
→ Homing speeds	0x6099	Specifies the two speeds used for Homing: In a typical cycle, the faster speed is used to find the home switch and for the offset move, the slower speed is used to find the index pulse.
→ Homing acceleration	0x609A	Specifies the acceleration during Homing
→ Home offset move distance	0x30B1	The distance to move away from a detected position upon end of the homing sequence
→ Home position	0x30B0	Allows to displace zero in the user's coordinate system
→ Current threshold for homing mode	0x30B2	The current threshold for current index homing methods

Table 3-27 Homing Mode – Commanding parameters

CONTROLWORD (HOMING MODE-SPECIFIC BITS)

Bit 15...9	Bit 8	Bit 7	Bit 6, 5	Bit 4	Bit 3...0
→ Table 6-126	Halt	→ Table 6-126	reserved	Homing operation start	→ Table 6-126

Table 3-28 Homing Mode – Controlword

Name	Value	Description
Homing operation start	0	Do not start homing procedure
	0→1	Start or continue homing procedure
Halt	0	Execute instruction of bit 4
	1	Stop axis with →Homing acceleration

Table 3-29 Homing Mode – Controlword bits

OUTPUT PARAMETERS

Parameter	Index	Description
→ Statusword	0x6041	Mode state can be observed by the statusword bits

Table 3-30 Homing Mode – Output parameters

STATUSWORD (HOMING MODE-SPECIFIC BITS)

Bit 15	Bit 14	Bit 13	Bit 12	Bit 11	Bit 10	Bit 9...0
Position referenced to home position	➔ Table 6-127	Homing error	Homing attained	➔ Table 6-127	Target reached	➔ Table 6-127

Table 3-31 Homing Mode – Statusword

Name	Value	Description
Bit 15 Position referenced to home position	0	The position is not referenced to the home position (for example homing not yet attained or position overflow)
	1	Homing was attained and the position is referenced to the home position

Table 3-32 Homing Mode – Statusword bit 15

Bit 13 Homing error	Bit 12 Homing attained	Bit 10 Target reached	Description
0	0	0	Homing procedure is in progress
0	0	1	Homing procedure is interrupted or not started
0	1	X	Homing procedure is completed successfully
1	0	X	Homing error occurred

Table 3-33 Homing Mode – Statusword bits 10, 12, and 13

3.5.3 Homing Methods

3.5.3.1 Homing Method 1 (Negative Limit Switch & Index)

The initial direction of the movement is negative (here to the left) if the negative limit switch is inactive (here shown as low).

- The axis moves with →Speed for switch search to the positive edge of the limit switch (1).
- The axis moves with →Speed for zero search to the negative edge of the limit switch and further to the first encoder index pulse after the negative edge of the limit switch (2).
- The axis moves the →Home offset move distance (3) in positive direction with →Speed for switch search. This point will be used as reference for all further moves and is set to →Home position (4).

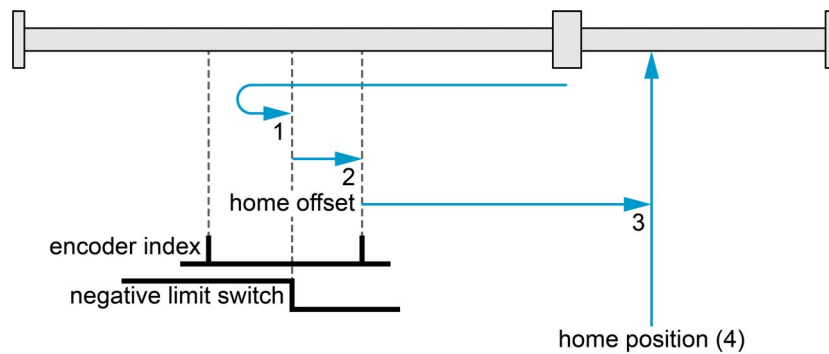

Figure 3-12 Homing method 1

3.5.3.2 Homing Method 2 (Positive Limit Switch & Index)

The initial direction of the movement is positive (here to the right) if the positive limit switch is inactive (here shown as low).

- The axis moves with →Speed for switch search to the positive edge of the limit switch (1).
- The axis moves with →Speed for zero search to the negative edge of the limit switch and further to the first encoder index pulse after the negative edge of the limit switch (2).
- The axis moves the →Home offset move distance (3) in negative direction with →Speed for switch search. This point will be used as reference for all further moves and is set to →Home position (4).

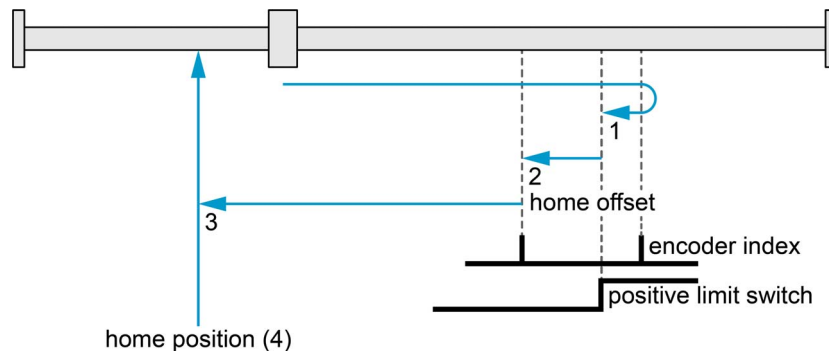

Figure 3-13 Homing method 2

3.5.3.3 Homing Method 7 (Home Switch Positive Speed & Index)

The method uses a home switch, which is active only during part of the movement. In effect, the switch acts as the position of the axis sweeps past the switch.

The initial direction of the movement is positive (here to the right) except when the home switch is already active upon start of the movement.

- a) The axis moves with →Speed for switch search to the positive edge of the limit switch (1).
- b) The axis moves with →Speed for zero search to the encoder index pulse (2).
- c) The axis moves the →Home offset move distance (3) with →Speed for switch search. This point will be used as reference for all further moves and is set to →Home position (4).

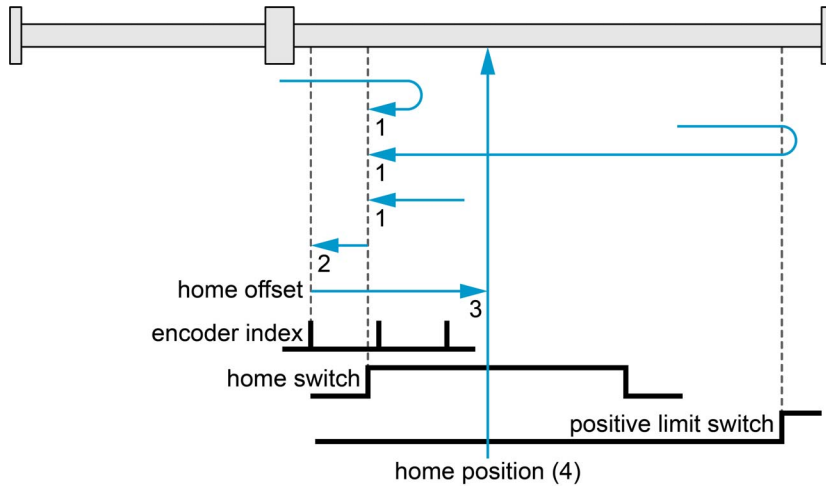

Figure 3-14 Homing method 7

3.5.3.4 Homing Method 11 (Home Switch Negative Speed & Index)

The method uses a home switch, which is active only during part of the movement. In effect, the switch acts as the position of the axis sweeps past the switch.

The initial direction of the movement is negative (here to the left) except when the home switch is already active upon start of the movement.

- a) The axis moves with →Speed for switch search to the positive edge of the limit switch (1).
- b) The axis moves with →Speed for zero search to the encoder index pulse (2).
- c) The axis moves the →Home offset move distance (3) with →Speed for switch search. This point will be used as reference for all further moves and is set to →Home position (4).

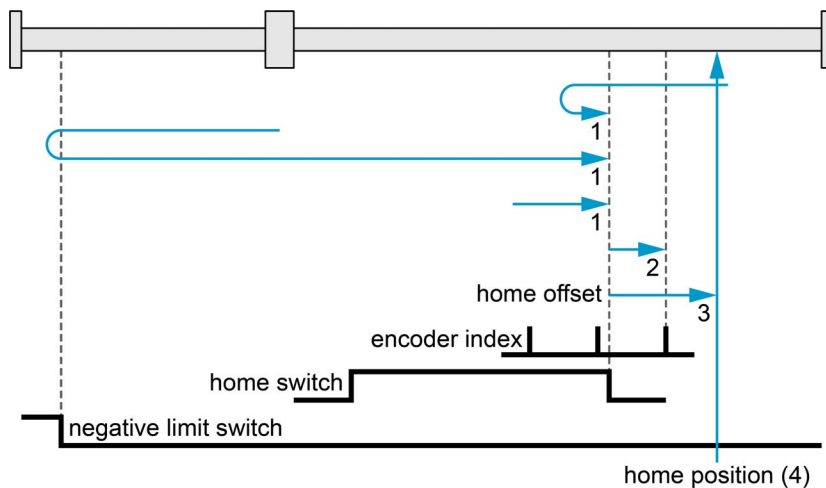

Figure 3-15 Homing method 11

3.5.3.5 Homing Method 17 (Negative Limit Switch)

The principle is similar to homing method 1 except that the →Home position is not dependent on the index pulse but only on the negative edge of the negative limit switch.

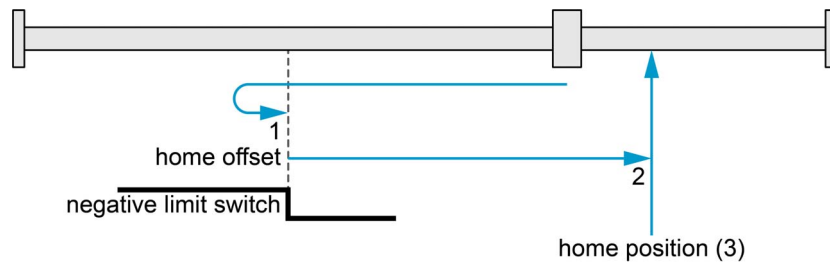

Figure 3-16 Homing method 17

3.5.3.6 Homing Method 18 (Positive Limit Switch)

The principle is similar to homing method 2 except that the →Home position is not dependent on the index pulse but only on the positive edge of the positive limit switch.

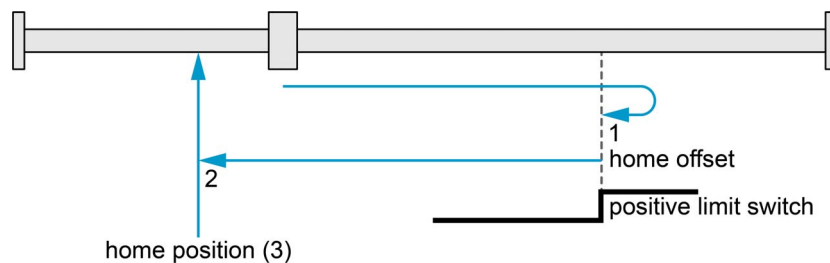

Figure 3-17 Homing method 18

3.5.3.7 Homing Method 23 (Home Switch Positive Speed)

The principle is similar to homing method 7 except that the →Home position is not dependent on the index pulse but only on the rising edge of the home switch.

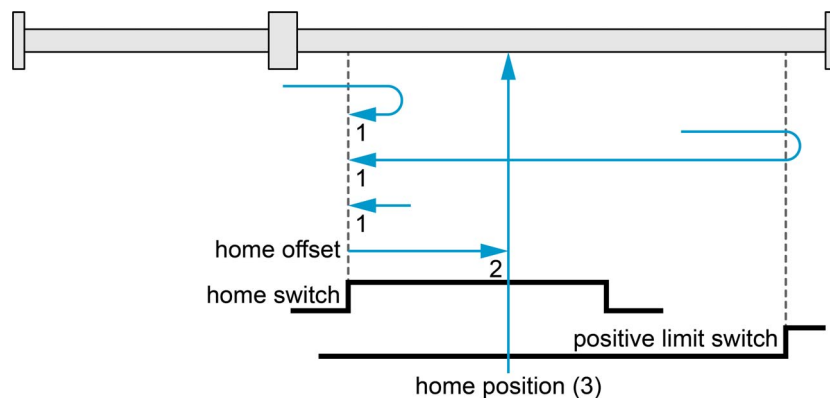

Figure 3-18 Homing method 23

3.5.3.8 Homing Method 27 (Home Switch Negative Speed)

The principle is similar to homing method 11 except that the →Home position is not dependent on the index pulse but only on the falling edge of the home switch.

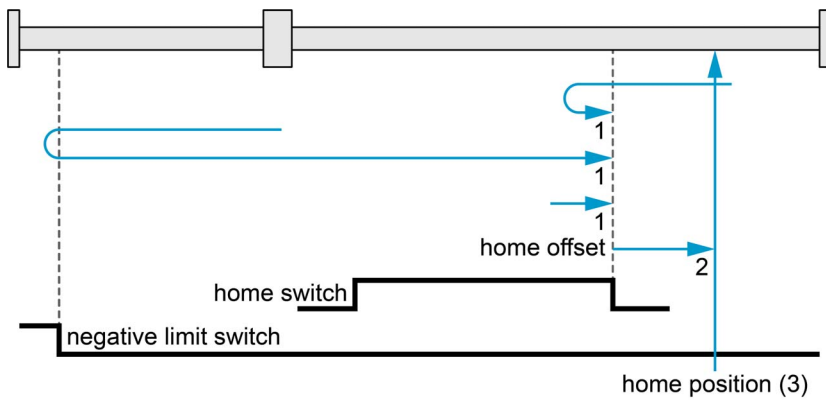

Figure 3-19 Homing method 27

3.5.3.9 Homing Method 33 (Index Negative Speed)

The direction for homing is negative (here to the left).

- a) The axis moves with →Speed for zero search to the next encoder index pulse (33).
- b) The axis moves the →Home offset move distance (2) with →Speed for switch search. This point will be used as reference for all further moves and is set to →Home position (4).

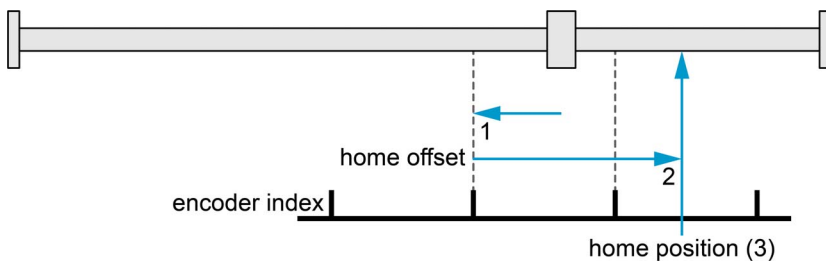

Figure 3-20 Homing method 33

3.5.3.10 Homing Method 34 (Index Positive Speed)

The direction for homing is positive (here to the right).

- a) The axis moves with →Speed for zero search to the next encoder index pulse (34).
- b) The axis moves the →Home offset move distance (2) with →Speed for switch search. This point will be used as reference for all further moves and is set to →Home position (4).

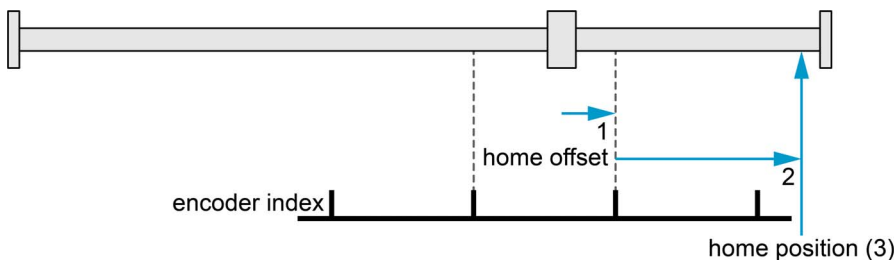

Figure 3-21 Homing method 34

3.5.3.11 Homing Method 37 (Actual Position)

The actual position is changed and considered as the future →Home position. The method may be used if the axis is disabled.

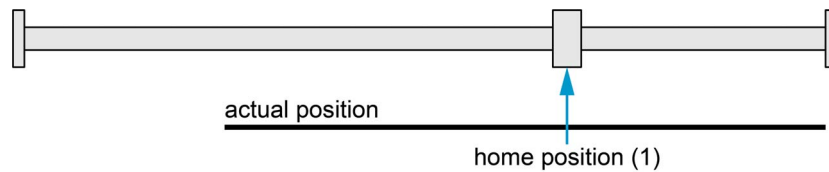

Figure 3-22 Homing method 37

3.5.3.12 Homing Method -1 (Current Threshold Positive Speed & Index)

The method uses a mechanical end stop on the right (positive) side. The edge is detected when the averaged output current rises above →Current threshold for homing mode.

- a) The axis moves with →Speed for switch search to the mechanical end stop (1).
- b) The axis moves with →Speed for zero search to the next encoder index pulse (2).
- c) The axis moves the →Home offset move distance (3) with →Speed for switch search. This point will be used as reference for all further moves and is set to →Home position (4).

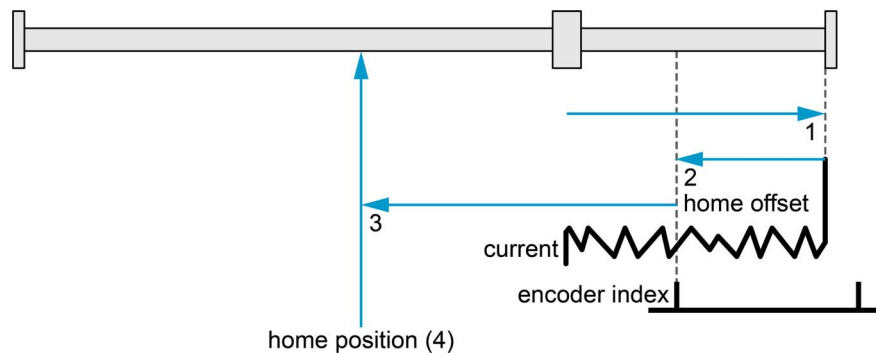

Figure 3-23 Homing method -1

3.5.3.13 Homing Method -2 (Current Threshold Negative Speed & Index)

The method uses a mechanical end stop on the left (negative) side. The edge is detected when the averaged output current rises above →Current threshold for homing mode.

- a) The axis moves with →Speed for switch search to the mechanical end stop (1).
- b) The axis moves with →Speed for zero search to the next encoder index pulse (2).
- c) The axis moves the →Home offset move distance (3) with →Speed for switch search. This point will be used as reference for all further moves and is set to →Home position (4).

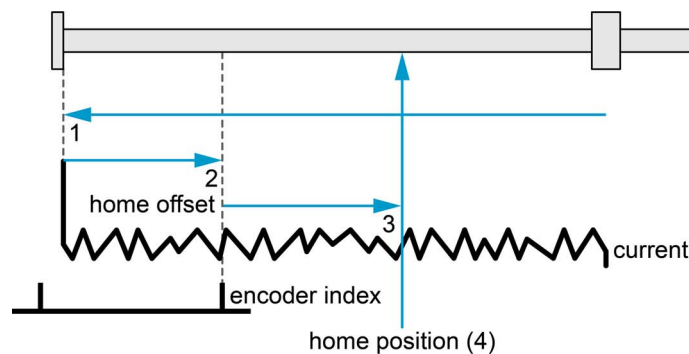

Figure 3-24 Homing method -2

3.5.3.14 Homing Method -3 (Current Threshold Positive Speed)

The principle is similar to homing method -1 except that the →Home position is not dependent on the index pulse but only on the mechanical end stop.

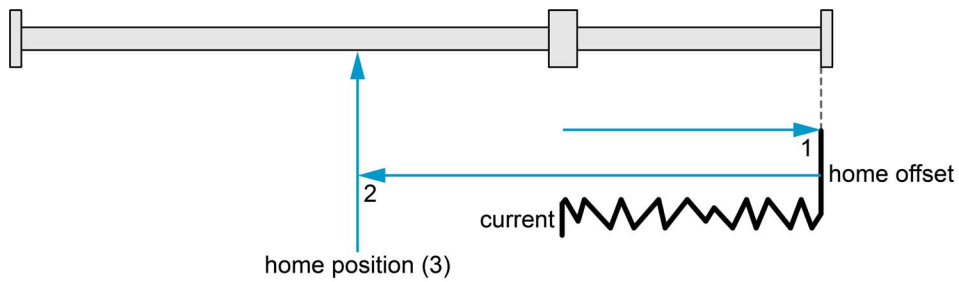

Figure 3-25 Homing method -3

3.5.3.15 Homing Method -4 (Current Threshold Negative Speed)

The principle is similar to homing method -2 except that the →Home position is not dependent on the index pulse but only on the mechanical end stop.

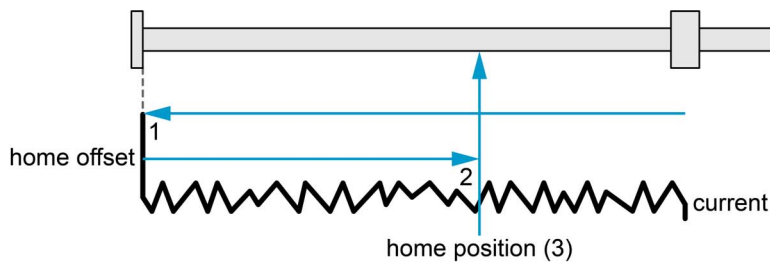

Figure 3-26 Homing method -4

3.6 Cyclic Synchronous Position Mode (CSP)

With Cyclic Synchronous Position Mode, the trajectory generator is located in the control device (not in the drive device). It provides a target position to the drive device in cyclic synchronous manner, thus the drive performing position control and torque control.

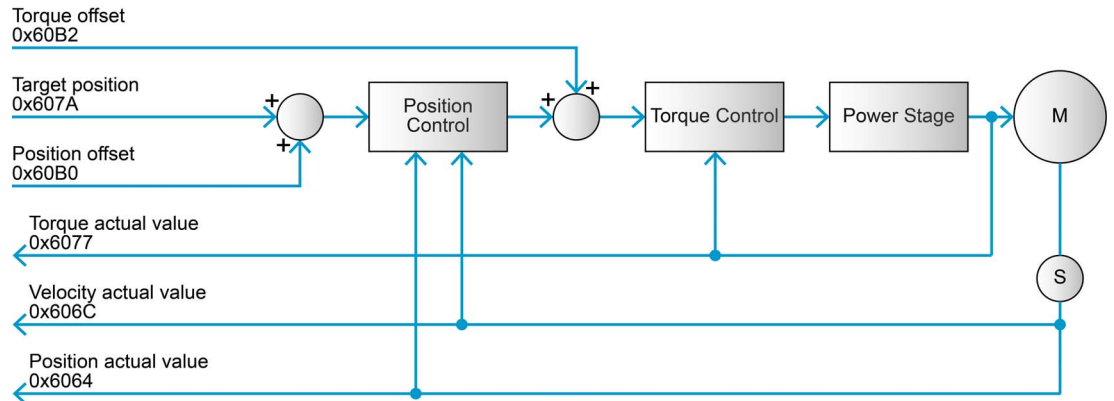

Figure 3-27 Cyclic Synchronous Position Mode – Overview

Cyclic Synchronous Position Mode is based on a position control function. The inputs are →Target position and (optionally) →Position offset. A linear interpolation based on the →Interpolation time period is executed between two position values. This interpolation is active for PDO communication only. The →Velocity offset is not taken into account.

Furthermore, an optional torque offset is being used for feed forward control. The input →Motor data is used to define limitations for the current value (torque). Other features specified in this mode are the function →Software position limit (used to restrict the range of values to avoid unintended positions) as well as →Max motor speed and →Max gear input speed (to limit and monitor the following error). Actual values for position, velocity, and torque are used as output to the control device.

Continued on next page.

Operating Modes

Cyclic Synchronous Position Mode (CSP)

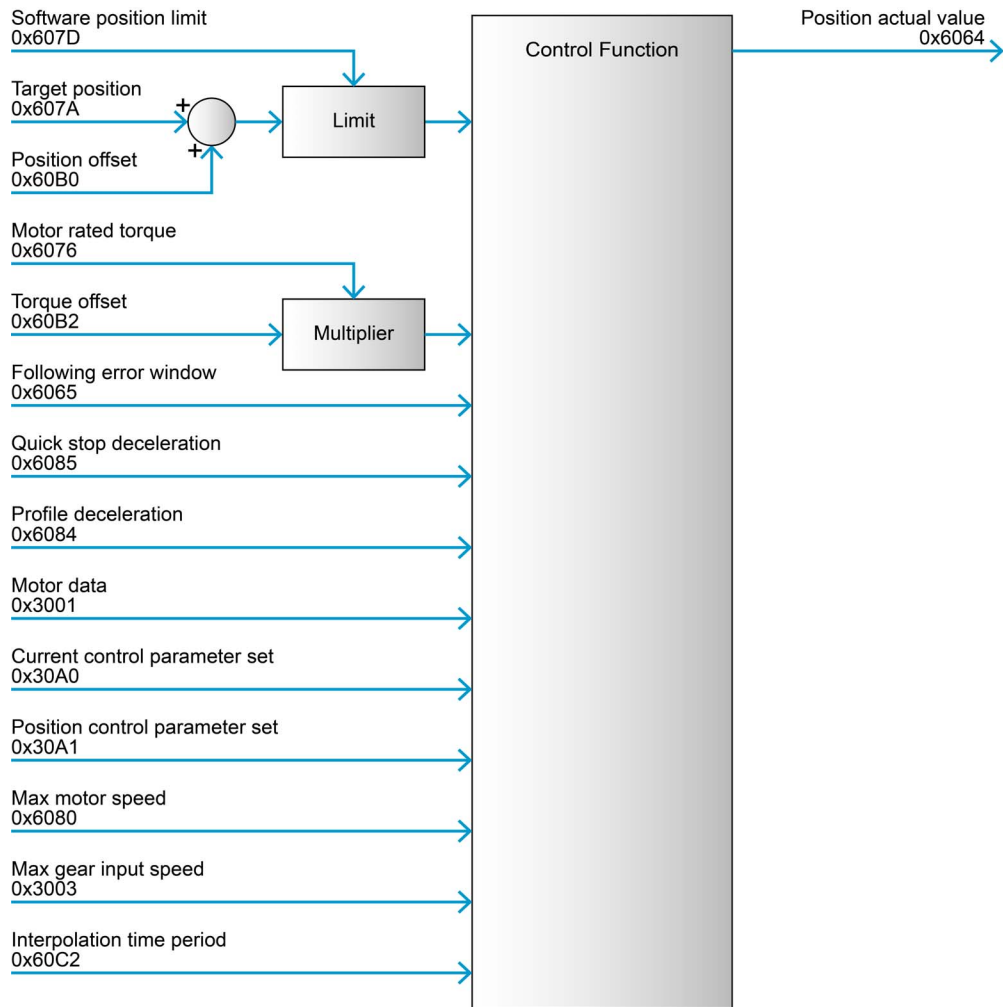

Figure 3-28 Cyclic Synchronous Position Mode – Block diagram

3.6.1 How to use «CSP»

CONFIGURATION PARAMETERS

Parameter	Index	Description
Nominal current (→Motor data)	0x3001	The maximal permissible continuous current of the motor
Motor torque constant (→Motor data)	0x3001	The torque constant of the motor
→Current control parameter set	0x30A0	Configuration of the current controller gains
→Position control parameter set	0x30A1	Configuration of the position controller.
→Quick stop deceleration	0x6085	Defines the deceleration for the quick stop ramp (*3)
→Profile deceleration	0x6084	Defines the deceleration for the slowdown ramp (*3)
→Following error window	0x6065	The maximal allowed difference of position actual value to position demand value. If exceeded, following error is generated.
→Software position limit	0x607D	Used to restrict the absolute position range. If the target position or the actual position exceeds the range, a software position limit error is generated.
→Motor rated torque	0x6076	Holds the value to which all torque objects are related to
→Max motor speed	0x6080	Indicates the configured maximal permitted speed for the motor. It serves as protection of the motor and is taken from the motor data sheet (active during PDO communication only).
→Max gear input speed	0x3003	Indicates the configured maximal permitted input speed of the gear. It serves as protection of the gear and is taken from the gear data sheet. Together with "Max motor speed", it limits the speed of the system (active during PDO communication only).
→Interpolation time period	0x60C2	Defines the time interval

(*3) Deceleration values are used for stopping only (and not for normal operation).

Table 3-34 Cyclic Synchronous Position Mode – Configuration parameters

COMMANDING PARAMETERS

Parameter	Index	Description
→Target position	0x607A	Position input value for the position controller (linear interpolation between PDO values)
→Position offset	0x60B0	Optional additive position value which is added to the target position (linear interpolation between PDO values)
→Torque offset	0x60B2	Optional torque feed forward input

Table 3-35 Cyclic Synchronous Position Mode – Commanding parameters

CONTROLWORD

Cyclic Synchronous Position Mode does not use mode-specific controlword bits.

OUTPUT PARAMETERS

Parameter	Index	Description
→ Torque actual value	0x6077	Actual motor torque value
→ Velocity actual value	0x606C	Actual velocity value [velocity units]
→ Position actual value	0x6064	Actual position is absolute and referenced to system zero position

Table 3-36 Cyclic Synchronous Position Mode – Output parameters

STATUSWORD (CYCLIC SYNCHRONOUS POSITION MODE-SPECIFIC BITS)

Bit 15, 14	Bit 13	Bit 12	Bit 11	Bit 10	Bit 9...0
→ Table 6-127	following error	drive follows command value	→ Table 6-127	reserved	→ Table 6-127

Table 3-37 Cyclic Synchronous Position Mode – Statusword

Name	Value	Description
drive follows command value	0	Drive does not follow the target value
	1	Drive is in state operation enables and follows the target and setpoint values of the control device
following error	0	No following error
	1	Difference of position demand value and position actual value exceeds the defined maximal following error

Table 3-38 Cyclic Synchronous Position Mode – Statusword bits

3.7 Cyclic Synchronous Velocity Mode (CSV)

With Cyclic Synchronous Velocity Mode, the trajectory generator is located in the control device (not in the drive device). It provides a target velocity to the drive device in cyclic synchronous manner, thus the drive velocity control and torque control.

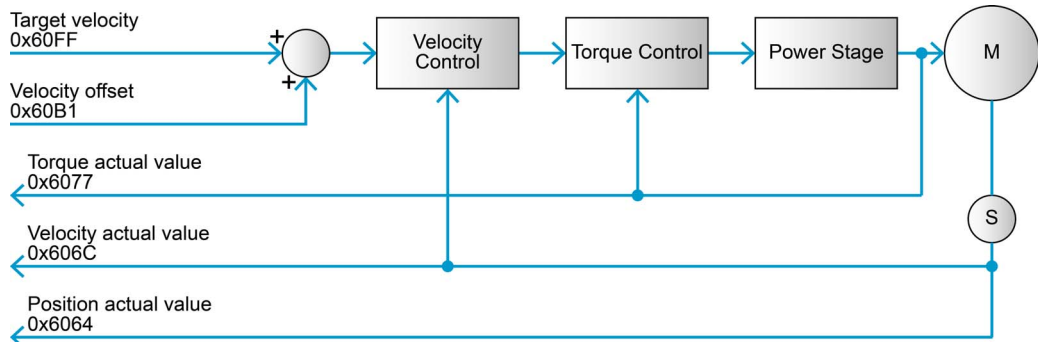

Figure 3-29 Cyclic Synchronous Velocity Mode – Overview

Cyclic Synchronous Velocity Mode is based on velocity control function. The inputs are → Target velocity. Optionally, additive velocity values may be provided by the control system in order to allow a second source for velocity feed forward control. A linear interpolation based on the → Interpolation time period is executed between two velocity values. This interpolation is active for PDO communication only. The → Torque offset is not taken into account.

The input → Motor data is used to define limitations for velocity and current values. Actual values for position, velocity, and torque are used as output to the control device

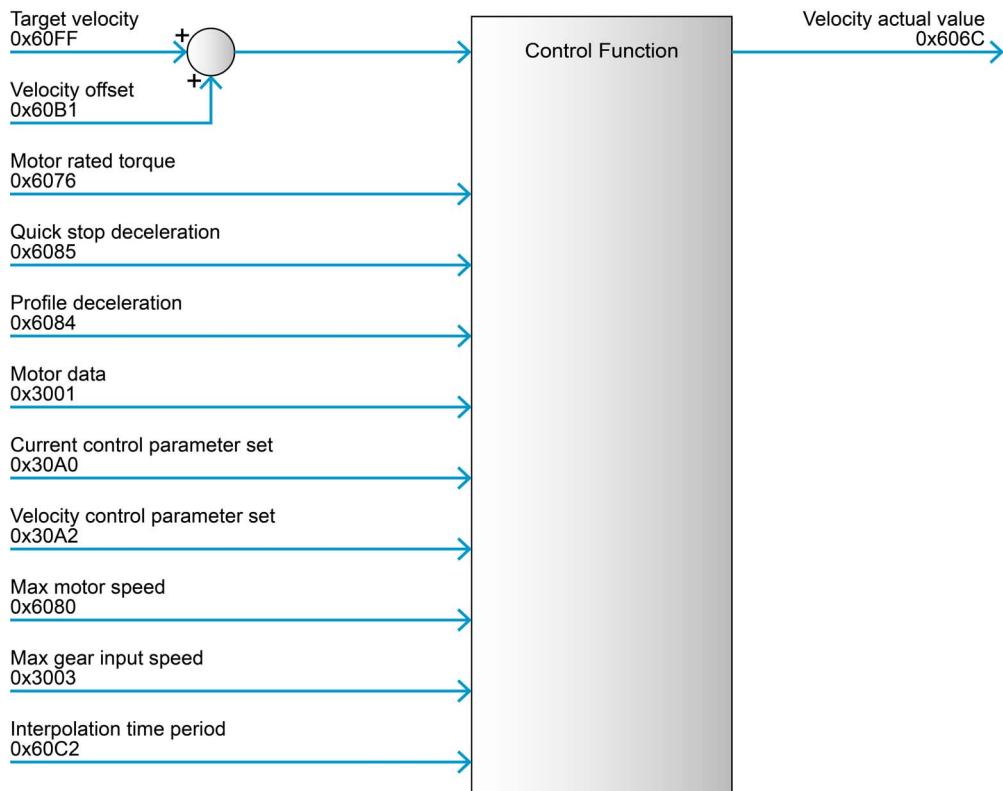

Figure 3-30 Cyclic Synchronous Velocity Mode – Block diagram

3.7.1 How to use «CSV»

CONFIGURATION PARAMETERS

Parameter	Index	Description
Nominal current (→Motor data)	0x3001	The maximal permissible continuous current of the motor
Motor torque constant (→Motor data)	0x3001	The torque constant of the motor
→Current control parameter set	0x30A0	Configuration of the current controller gains
→Velocity control parameter set	0x30A2	Configuration of the velocity controller
→Quick stop deceleration	0x6085	Defines the deceleration for the quick stop ramp (*3)
→Profile deceleration	0x6084	Defines the deceleration for the slowdown ramp (*3)
→Software position limit	0x607D	Used to restrict the absolute position range. If the actual position exceeds the range, a software position limit error is generated.
→Motor rated torque	0x6076	Holds the value to which all torque objects are related to
→Max motor speed	0x6080	Indicates the configured maximal permitted speed for the motor. It serves as protection of the motor and is taken from the motor data sheet (active during PDO communication only).
→Max gear input speed	0x3003	Indicates the configured maximal permitted input speed of the gear. It serves as protection of the gear and is taken from the gear data sheet. Together with "Max motor speed", it limits the speed of the system (active during PDO communication only).
→Interpolation time period	0x60C2	Defines the time interval

(*3) Deceleration values are used for stopping only (and not for normal operation).

Table 3-39 Cyclic Synchronous Velocity Mode – Configuration parameters

COMMANDING PARAMETERS

Parameter	Index	Description
→Target velocity	0x60FF	Velocity input value for the velocity controller
→Velocity offset	0x60B1	Optional velocity feed forward input

Table 3-40 Cyclic Synchronous Velocity Mode – Commanding parameters

CONTROLWORD

Cyclic Synchronous Velocity Mode does not use mode-specific controlword bits.

OUTPUT PARAMETERS

Parameter	Index	Description
→Torque actual value	0x6077	Actual motor torque value
→Velocity actual value	0x606C	Actual velocity value [velocity units]
→Position actual value	0x6064	Actual position is absolute and referenced to system zero position

Table 3-41 Cyclic Synchronous Velocity Mode – Output parameters

STATUSWORD (CYCLIC SYNCHRONOUS VELOCITY MODE-SPECIFIC BITS)

Bit 15, 14	Bit 13	Bit 12	Bit 11	Bit 10	Bit 9...0
→ Table 6-127	reserved	drive follows command value	→ Table 6-127	reserved	→ Table 6-127

Table 3-42 Cyclic Synchronous Velocity Mode – Statusword

Name	Value	Description
drive follows command value	0	Drive does not follow the target value
	1	Drive is in state operation enables and follows the target and setpoint values of the control device

Table 3-43 Cyclic Synchronous Velocity Mode – Statusword bits

3.8 Cyclic Synchronous Torque Mode (CST)

With Cyclic Synchronous Torque Mode, the trajectory generator is located in the control device (not in the drive device). It provides a target torque to the drive device in cyclic synchronous manner, thus the drive performing torque control.

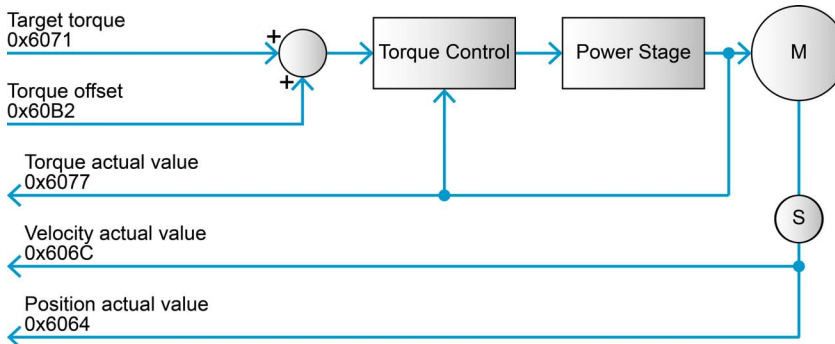

Figure 3-31 Cyclic Synchronous Torque Mode – Overview

Cyclic Synchronous Torque Mode is based on the current control function. The inputs are →Target torque and (optionally) →Torque offset. The input →Motor data is used to define limitations for velocity and current values. Actual values for position, velocity, and torque are used as output to the control device.

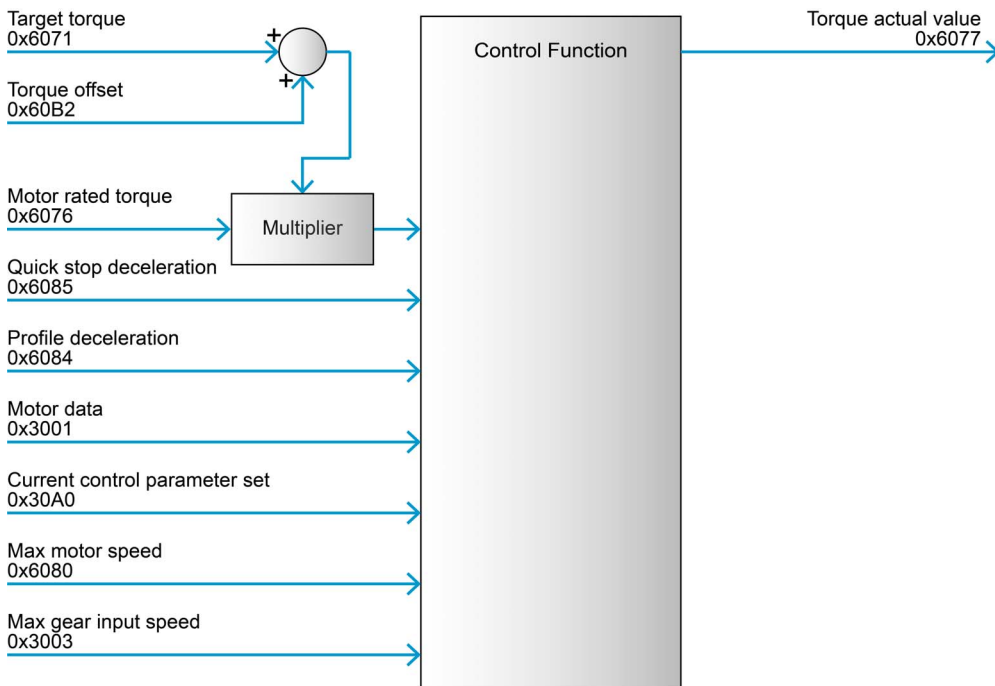

Figure 3-32 Cyclic Synchronous Torque Mode – Block diagram

3.8.1 How to use «CST»

CONFIGURATION PARAMETERS

Parameter	Index	Description
Nominal current (→Motor data)	0x3001	The maximal permissible continuous current of the motor
Motor torque constant (→Motor data)	0x3001	The torque constant of the motor
→Max motor speed	0x6080	Indicates the configured maximal allowed speed for the motor. It serves as protection of the motor and is taken from the motor data sheet.
→Max gear input speed	0x3003	Indicates the configured maximal permitted input speed of the gear. It serves as protection of the gear and is taken from the gear data sheet. Together with "Max motor speed", it limits the speed of the system.
→Current control parameter set	0x30A0	Configuration of the current controller gains
→Quick stop deceleration	0x6085	Defines the deceleration for the quick stop ramp (*4)
→Profile deceleration	0x6084	Defines the deceleration for the slowdown ramp (*4)
→Motor rated torque	0x6076	Holds the value to which all torque objects are related to
→Software position limit	0x607D	Contains the sub-parameters "Min position limit" and "Max position limit" that define the absolute position limits of the position demand value and position actual value. A new target position will be checked against these limits.

(*4) Deceleration values are used for stopping only (and not for normal operation).

Table 3-44 Cyclic Synchronous Torque Mode – Configuration parameters

COMMANDING PARAMETERS

Parameter	Index	Description
→Target torque	0x6071	Torque input value for the torque controller
→Torque offset	0x60B2	Optional additive torque which is added to the target torque value

Table 3-45 Cyclic Synchronous Torque Mode – Commanding parameters

CONTROLWORD

Cyclic Synchronous Torque Mode does not use mode-specific controlword bits.

OUTPUT PARAMETERS

Parameter	Index	Description
→Torque actual value	0x6077	Actual motor torque value
→Velocity actual value	0x606C	Actual velocity value
→Position actual value	0x6064	Actual position is absolute and referenced to system zero position

Table 3-46 Cyclic Synchronous Torque Mode – Output parameters

Operating Modes

Cyclic Synchronous Torque Mode (CST)

STATUSWORD (CYCLIC SYNCHRONOUS TORQUE MODE-SPECIFIC BITS)

Bit 15, 14	Bit 13	Bit 12	Bit 11	Bit 10	Bit 9...0
➔ Table 6-127	reserved	drive follows command value	➔ Table 6-127	reserved	➔ Table 6-127

Table 3-47 Cyclic Synchronous Torque Mode – Statusword

Name	Value	Description
drive follows command value	0	Drive does not follow the target value
	1	Drive is in state operation enables and follows the target and setpoint values of the control device

Table 3-48 Cyclic Synchronous Torque Mode – Statusword bits

3.9 Position Control Function

Used for position-based modes, such as «Profile Position Mode» and «Homing Mode».

The control loop is fed with the «Position demand value» and «Position actual value» (the output of the position detection unit) like an encoder as input parameter. The behavior of the control may be influenced by externally applicable control parameters (Position Control Parameter Set). The output of the controller is a current demand value, which serves as input for the current controller.



Annotation

Items marked with an asterisk (*) refer to internal values.

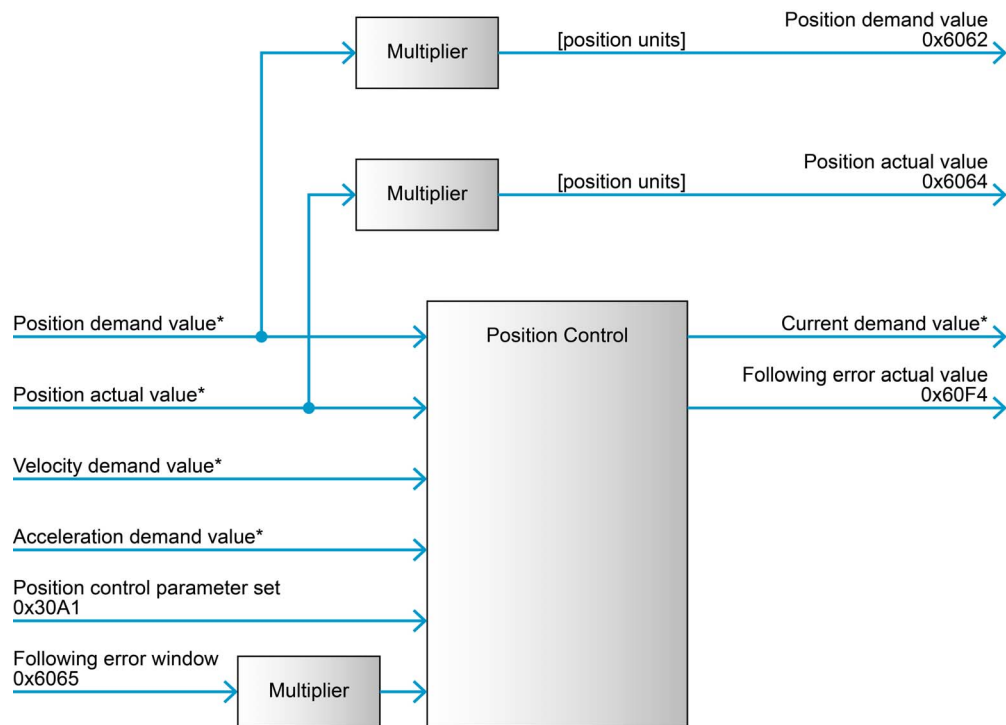

Figure 3-33 Position Control Function – Block diagram

3.9.1 How to use «Position Control Function»

CONFIGURATION PARAMETERS

Parameter	Index	Description
→Following error window	0x6065	Defines the following error window. If the difference between Position Actual Value and Position Demand Value is larger than the following error window, a following error will occur.
→Position control parameter set	0x30A1	Configuration of the position controller. The parameters are defined by the controller properties bandwidth, reset time, and damping factor.

Table 3-49 Position Control Function – Configuration parameters

COMMANDING PARAMETERS

There are no commanding parameters. The Position Control Function is directly commanded by position-based operating modes (such as Profile Position Mode, Homing Mode).

OUTPUT PARAMETERS

Parameter	Index	Description
→Position demand value	0x6062	The operation mode's output. It is used as input for the position control function. Generally, the value is the trajectory generator output.
→Position actual value	0x6064	The actual position is absolute and referenced to system zero position in position units.

Table 3-50 Position Control Function – Output parameters

3.10 Velocity Control Function

Used for velocity-based modes, such as «Profile Velocity Mode».

The control loop is fed with the «Velocity demand value» and «Position actual value» (the output of the position detection unit) like an encoder as input parameter. The behavior of the control may be influenced by externally applicable control parameters. The output of the controller is a current demand value, which serves as input for the current controller.



Annotation

Items marked with an asterisk (*) refer to internal values.

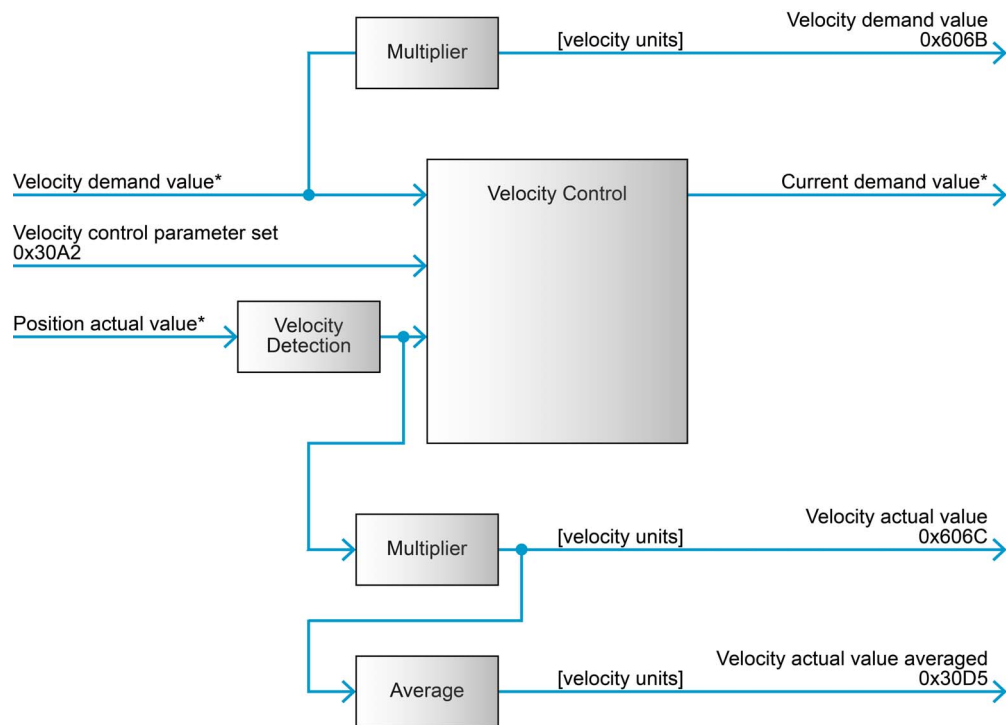

Figure 3-34 Velocity Control Function – Block diagram

3.10.1 How to use «Velocity Control Function»

CONFIGURATION PARAMETERS

Parameter	Index	Description
→Velocity control parameter set	0x30A2	Configuration of the velocity controller gains

Table 3-51 Velocity Control Function – Configuration parameters

COMMANDING PARAMETERS

There are no commanding parameters. The Velocity Control Function is directly commanded by velocity-based operating modes (such as Profile Velocity Mode).

OUTPUT PARAMETERS

Parameter	Index	Description
→Velocity demand value	0x606B	The operation mode's output. It is used as input for the velocity control function. Generally, the value is the output of the trajectory generator.
→Velocity actual value	0x606C	The actual velocity value
→Velocity actual value averaged	0x30D5	The averaged actual velocity value

Table 3-52 Velocity Control Function – Output Parameters

3.11 Current Control Function

All operating modes are based on the current control function. The «Current demand value» is received from a superordinate position or the velocity controller.



Annotation

Items marked with an asterisk (*) refer to internal values.

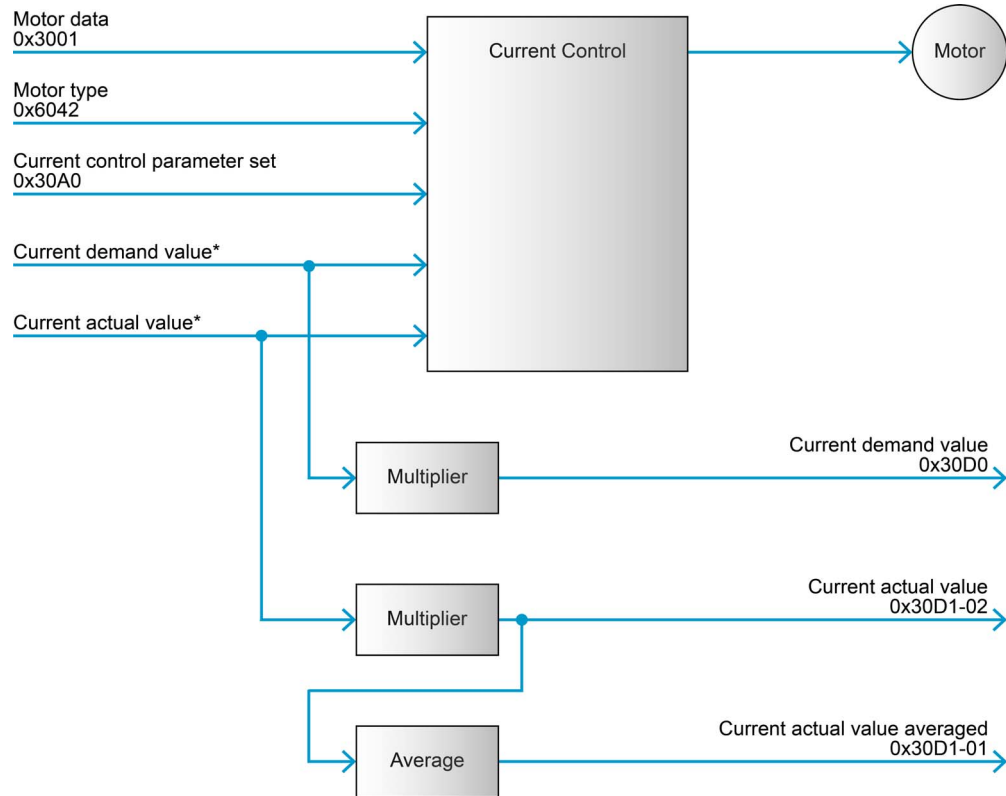

Figure 3-35 Current Control Function – Block diagram

3.11.1 How to use «Current Control Function»

CONFIGURATION PARAMETERS

Parameter	Index	Description
→ Current control parameter set	0x30A0	Configuration of the current controller gains
→ Motor data	0x3001	Used for configuration of motor-dependent parameters
→ Motor type	0x6402	Used to define the type of motor

Table 3-53 Current Control Function – Configuration parameters

COMMANDING PARAMETERS

There are no commanding parameters. The Current Control Function is commanded by the control loops «Position control function» or «Velocity control function», or directly by operating mode «Cyclic Synchronous Torque Mode».

OUTPUT PARAMETERS

Parameter	Index	Description
→ Current demand value	0x30D0	Set value for current controller
→ Current actual values	0x30D1	The averaged and actual current value

Table 3-54 Current Control Function – Output parameters

3.11.2 Output Current Limitation according to I²t Method

With properly setup → Motor data, the device will limit the output current according to I²t method with the parameters «Nominal current», «Output current limit», and «Thermal time constant winding». The I²t method assumes an ambient temperature of 25 °C. If this condition is not fulfilled, the output current must be reduced by adjusting the above mentioned parameters to the actual ambient temperature.

Heating-up of the motor is given as follows:

$$\vartheta = P_V \cdot R_{th} \cdot \left(1 - e^{-\frac{t}{\tau_{th}}} \right) + \vartheta_a \cdot e^{-\frac{t}{\tau_{th}}}$$

ϑ calculated actual winding temperature

P_V thermal dissipation loss

R_{th} thermal resistance

ϑ_a temperature at beginning of measuring period

τ_{th} thermal time constant winding

Use the scale to determine the time during which the device can source a current (→ Figure 3-36).

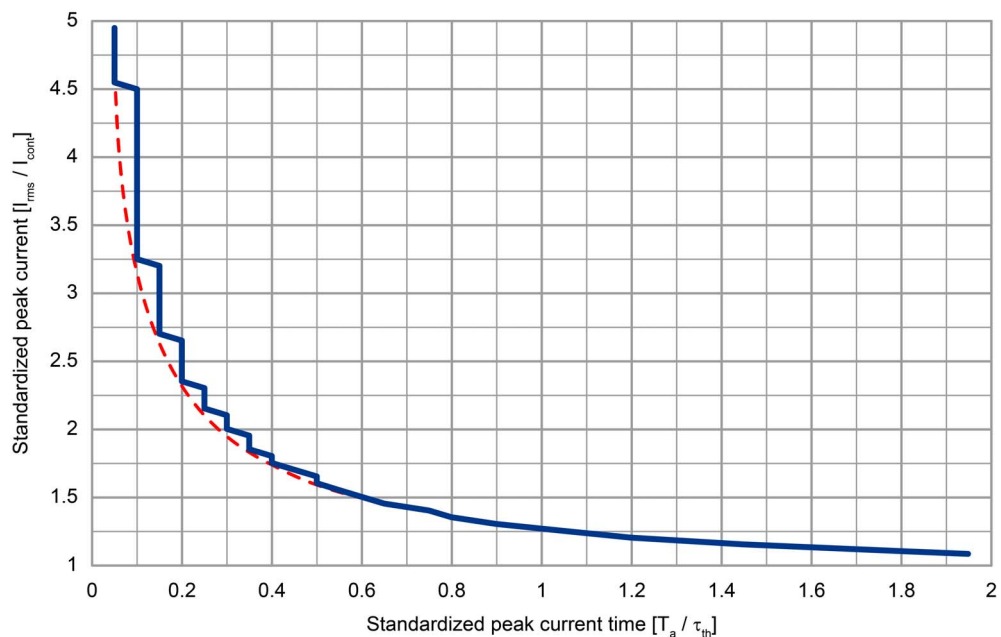

Figure 3-36 Standardized peak current vs. standardized peak current time

EXAMPLE:

Given configuration (for details → “Motor data” on page 6-145):

- Current limit: 1470 mA
- Output current limit: 2940 mA
- Thermal time constant winding [τ_{th}]: 2.8

At acceleration time [T_a], the motor needs a higher acceleration current [I_a]. The EPOS4's current limiting method according to I2t fulfills this need.

For how long (maximal) does the device source the higher acceleration current [I_a] = 2940 mA?

- Standardized peak current = 2940 mA / 1470 mA = 2
- Standardized peak current time -> 0.3
- The resulting acceleration time $T_p = 0.3 \cdot \text{thermal time constant winding} = 0.3 \cdot 2.8 \text{ s} = 840 \text{ ms}$.

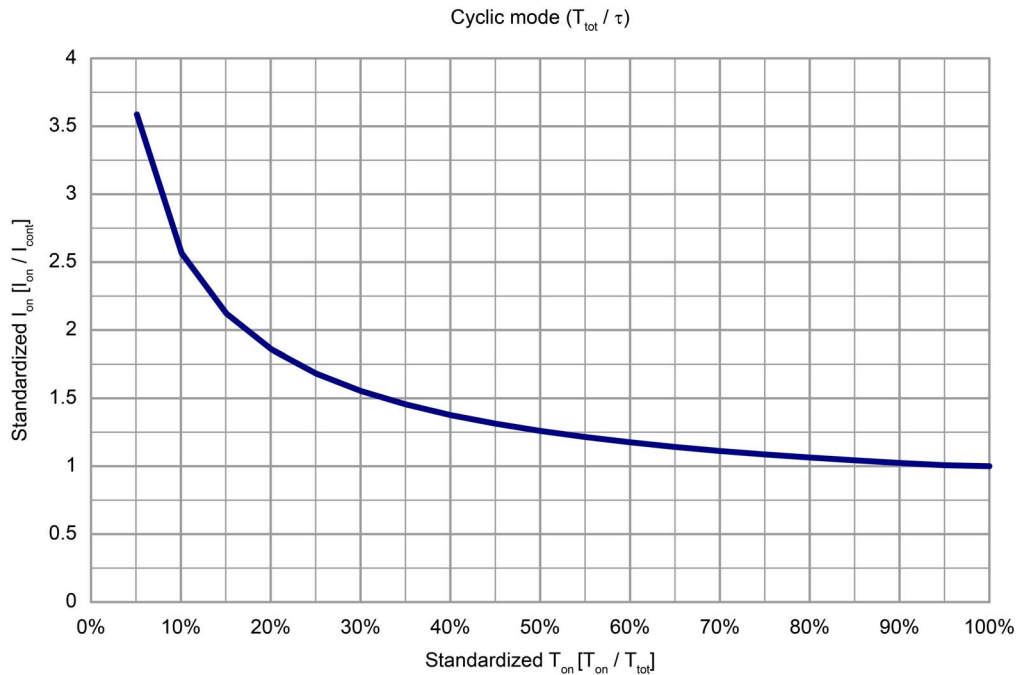

Figure 3-37 Cyclic mode standardized vs. standardized “ON time”

- standardized T_{on} ratio of “ON time” vs. total time
- standardized I_{on} current at “ON time” standardized with «Continuous current limit»

EXAMPLE:

Given configuration (for details → “Motor data” on page 6-145):

- Application in “cyclic mode” – the current is switched on/off every 2.8 s.
- Thermal time constant winding: 2.8 s
- Continuous current limit: 1470 mA

For the “ON time” of 280 ms (10%), a standardized output current of 2.6 is possible. Therefore, the possible output current $I_{\text{on}} = 2.6 \cdot \text{Continuous current limit} = 2.6 \cdot 1470 \text{ mA} = 3822 \text{ mA}$.

4 Inputs and Outputs

4.1 Digital Inputs

Available are predefined functions and general purpose inputs for process control.

Configuration of the digital input functions is done with →“Configuration of digital inputs” on page 6-185, the polarity is set with →“Digital input properties” on page 6-184.

The input logic state is read with →“Digital input properties” on page 6-184 while the functionality state is read with →“Digital inputs” on page 6-225.

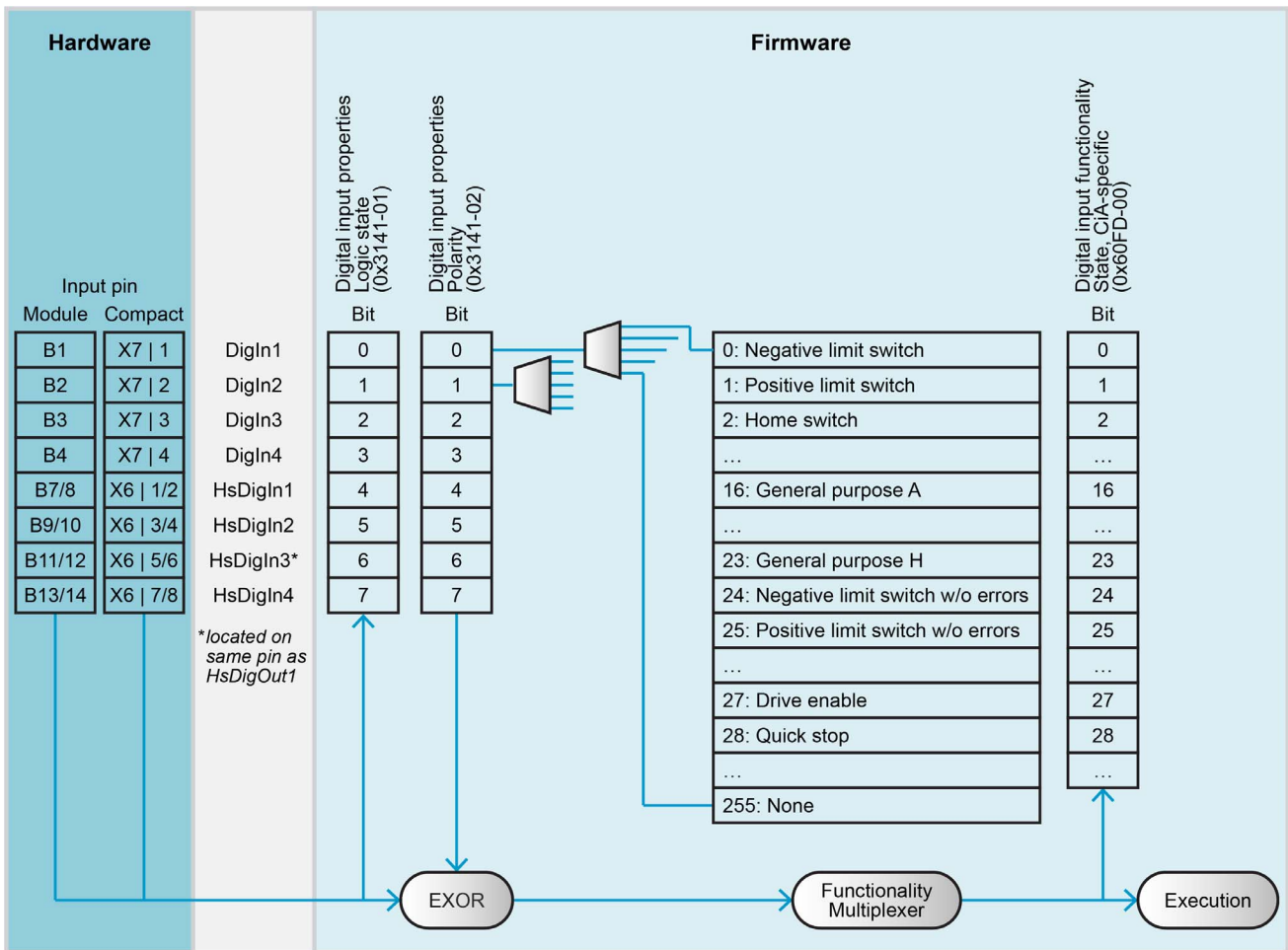

Figure 4-38 Digital input functionality

DIGITAL INPUT TIMING BEHAVIOR

- Hardware**
 For details on voltage levels and switching delays →separate document «Hardware Reference» of respective controller.
- Software filter**
 The digital inputs are filtered to suppress spikes. For “regular” digital inputs, the filter has a length of 1 ms, for high-speed inputs the filter length is 500 μs. Therefore, to detect a state change (edge), the input level must be stable for more than 1 ms, respectively 500 μs.
- Update rates**
 The digital input functionality states (→Digital inputs) and the →Digital input properties are updated with 1 kHz.

4.2 Digital Outputs

Available are predefined functions and general purpose outputs for process control.

Configuration of the digital output functions is done with →“Configuration of digital outputs” on page 6-188, the polarity is set with →“Digital output properties” on page 6-187.

The functionality state can be set with →“Digital outputs” on page 6-226, the logic state of the corresponding pin can be read with →“Digital output properties” on page 6-187.

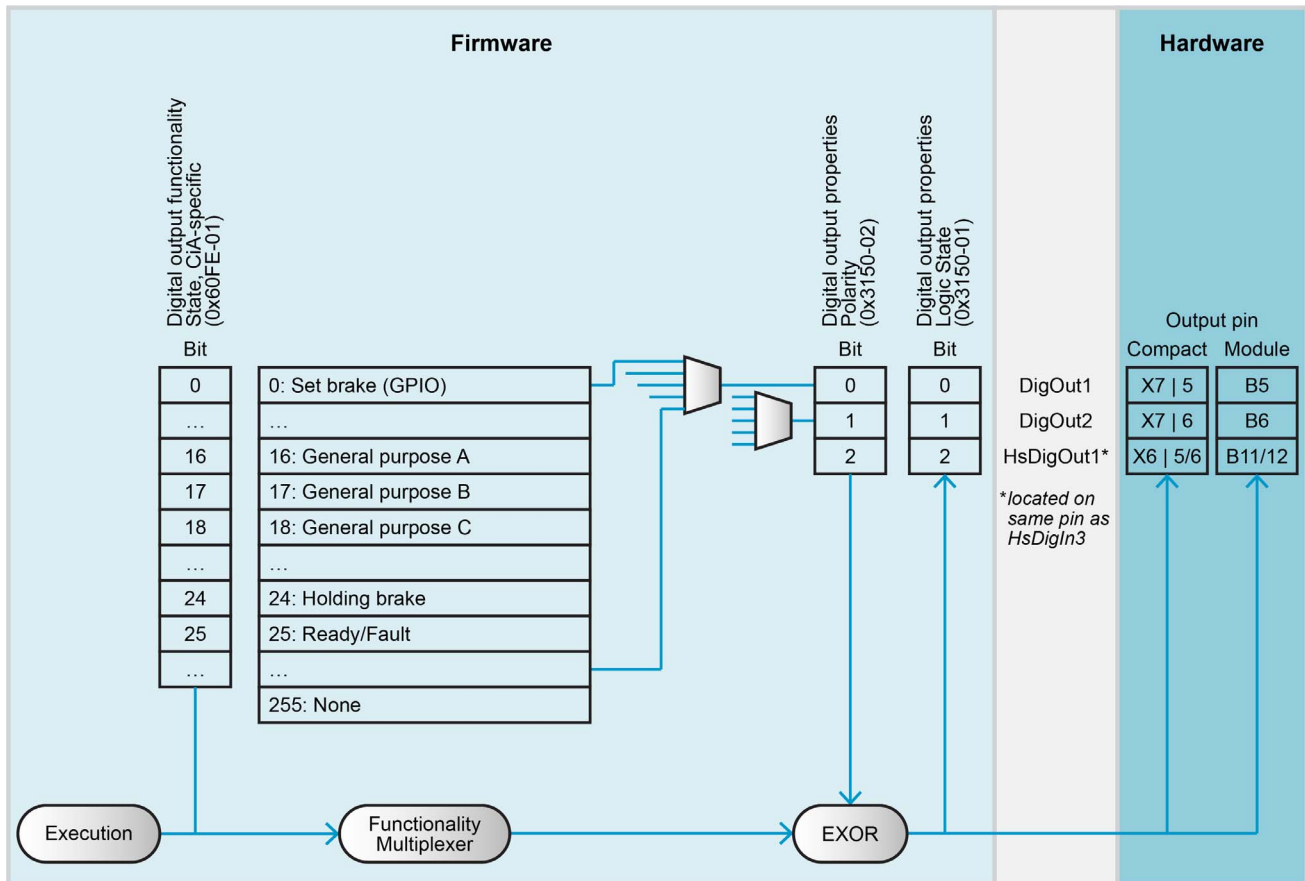

Figure 4-39 Digital output functionality

DIGITAL OUTPUT TIMING BEHAVIOR

- **Hardware**
For details on voltage levels and switching delays →separate document «Hardware Reference» of respective controller.
- **Update rates**
Digital outputs (→Digital outputs) are updated when the object is written, no update rate applies. The same applies for the logic state (→Digital output properties).

4.3 Analog Inputs

The analog inputs may be used for general purpose process values, such as temperature, pressure, torque from an external sensor, etc. The values are given in →“Analog input properties” on page 6-191.

4.4 Analog Outputs

The analog outputs may be used for general purpose. The outputs are set by →“Analog output general purpose” on page 6-195 and displayed in →“Analog output properties” on page 6-193.

Configuration of the analog output functions is done with →“Configuration of analog outputs” on page 6-194.

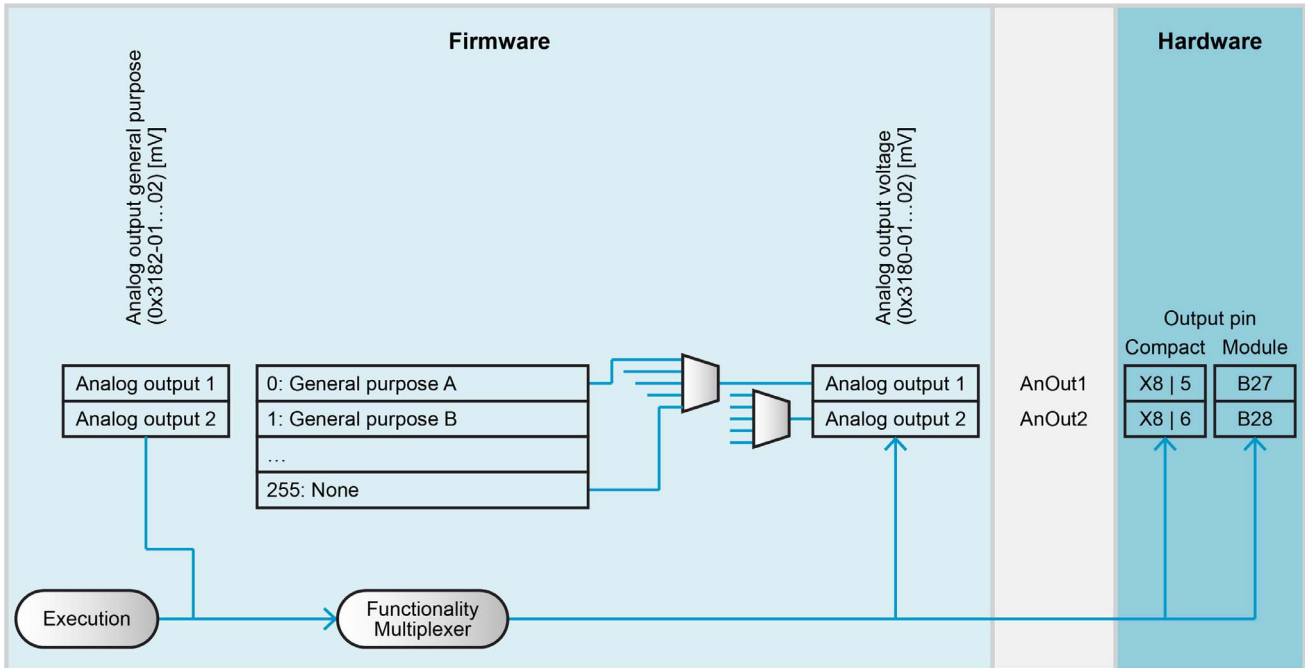

Figure 4-40 Analog output functionality

ANALOG OUTPUT TIMING BEHAVIOR

- **Hardware**
For details on voltage levels, resolution, and bandwidth →separate document «Hardware Reference» of respective controller.
- **Update rates**
Analog outputs configured as general purpose are updated when the object is written, no update rate applies.

••page intentionally left blank••

5 Communication

The EPOS4 supports communication profiles for USB, RS232, CANopen, and EtherCAT. You can find detailed information on the subject in separate document → «EPOS4 Communication Guide». For sources of supply see → chapter “1.1.6 Sources for additional Information” on page 1-9.

5.1 USB & RS232 Communication

The EPOS4's USB interface follows the «Universal Serial Bus Specification Revision 2.0».

The EPOS4's communication protocol uses the RS232 standard to transmit data over a 3-wire cable.

The EPOS4 always communicates as a slave and uses the «maxon Serial V2» protocol.



Find details here: → «EPOS4 Communication Guide», chapter “2 USB & RS232 Communication”

5.2 CAN Communication

The EPOS4's CAN interface follows the CiA CANopen specifications:

- CiA 301 V4.2; CANopen application layer and communication profile
- CiA 306 V1.3; CANopen electronic data sheet specification
- CiA 402 V4.0; CANopen drives and motion control device profile



Find details here: → «EPOS4 Communication Guide», chapter “3 CAN Communication”

5.3 EtherCAT Communication

The EPOS4 can be extended with EtherCAT communication functionality. Depending on the hardware version this is done by using either an «EPOS4 EtherCAT Card» in one of the provided extension slots or a connector board with EtherCAT functionality.

The EPOS4's EtherCAT communication follows the EtherCAT Technology Group's and CiA CANopen specifications:

- ETG.1000 V1.0.4; EtherCAT Specification
- ETG.1020 V1.2.0; EtherCAT Protocol Enhancements Specification
- ETG.2000 V1.0.9; EtherCAT Slave Information (ESI) Specification
- CiA 402 V4.0; CANopen drives and motion control device profile



Find details here: → «EPOS4 Communication Guide», chapter “4 EtherCAT Communication”

5.4 Gateway Communication (USB/RS232 to CAN)

The EPOS4 provides USB-to-CAN and RS232-to-CAN gateways that permit the master to access all other EPOS4 or EPOS2 devices connected to the CAN bus via USB port or RS232 interface. In addition, other CANopen devices (I/O modules) that support the CANopen standard CiA 301 may also be accessed.



Find details here: → «EPOS4 Communication Guide», chapter “5 Gateway Communication (USB or RS232 to CAN)”

6 Object Dictionary

6.1 Overview

6.1.1 Object Data Types

Index	Name	Base type	Description	Size [Bits]	Range
0x0001	BOOLEAN	BOOL	False/True	1	0.1
0x0002	INTEGER8	SINT	Short Integer	8	$-2^7 \dots 2^7 - 1$
0x0003	INTEGER16	INT	Integer	16	$-2^{15} \dots 2^{15} - 1$
0x0004	INTEGER32	DINT	Double Integer	32	$-2^{31} \dots 2^{31} - 1$
0x0015	INTEGER64	LINT	Long Integer	64	$-2^{63} \dots 2^{63} - 1$
0x0005	UNSIGNED8	USINT	Unsigned Short Integer	8	$0 \dots 2^8 - 1$
0x0006	UNSIGNED16	UINT	Unsigned Integer	16	$0 \dots 2^{16} - 1$
0x0007	UNSIGNED32	UDINT	Unsigned Double Integer	32	$0 \dots 2^{32} - 1$
0x001B	UNSIGNED64	ULINT	Unsigned Long Integer	64	$0 \dots 2^{64} - 1$
0x0009	VISIBLE_STRING	STRING(n)	Visible String (1 octet per character)	8*n	–
0x000A	OCTET_STRING	ARRAY[0...n] of USINT	Sequence of octets (data type USINT)	8*(n+1)	–
0x0021	PDO_MAPPING	–	PDO mapping Parameter Record	–	–
0x0023	IDENTITY	–	Identity Parameter Record	–	–

Table 6-55 Object data types

6.1.2 Object Codes

Object code	Object name
0x0007	VAR
0x0008	ARRAY
0x0009	RECORD

Table 6-56 Object codes

6.1.3 Object Access Types

Access type	Description
RW	read and write access
RO	read only access
WO	write only access
CONST	read only access value is constant

Table 6-57 Object access types

6.1.4 Object Flags

Flag	Code	Description
PDO mapping	TXPDO, RXPDO	Entry can be mapped as TxPdo or as RxPdo
Backup	YES/NO	Entry can be stored/not stored in non-volatile memory

Table 6-58 Object flags

6.1.5 Entries Overview

Index	Name	Object code
0x1000	→Device type	VAR
0x1001	→Error register	VAR
0x1003	→Error history	ARRAY
0x1005	→COB-ID SYNC	VAR
0x1008	→Manufacturer device name	VAR
0x1010	→Store parameters	ARRAY
0x1011	→Restore default parameters	ARRAY
0x1014	→COB-ID EMCY	VAR
0x1016	→Consumer heartbeat time	ARRAY
0x1017	→Producer heartbeat time	VAR
0x1018	→Identity object	RECORD
0x10F3	→Diagnosis history	RECORD
0x1200	→SDO server parameter	RECORD
0x1400	→Receive PDO 1 parameter	RECORD
0x1401	→Receive PDO 2 parameter	RECORD
0x1402	→Receive PDO 3 parameter	RECORD
0x1403	→Receive PDO 4 parameter	RECORD
0x1600	→Receive PDO 1 mapping	RECORD
0x1601	→Receive PDO 2 mapping	RECORD
0x1602	→Receive PDO 3 mapping	RECORD
0x1603	→Receive PDO 4 mapping	RECORD
0x1800	→Transmit PDO 1 parameter	RECORD
0x1801	→Transmit PDO 2 parameter	RECORD
0x1802	→Transmit PDO 3 parameter	RECORD
0x1803	→Transmit PDO 4 parameter	RECORD
0x1A00	→Transmit PDO 1 mapping	RECORD
0x1A01	→Transmit PDO 2 mapping	RECORD
0x1A02	→Transmit PDO 3 mapping	RECORD
0x1A03	→Transmit PDO 4 mapping	RECORD
0x1C00	→SYNC manager communication type	ARRAY
0x1C12	→SYNC manager 2 PDO assignment	ARRAY
0x1C13	→SYNC manager 3 PDO assignment	ARRAY
0x1C32	→SYNC manager 2 parameter	RECORD
0x1C33	→SYNC manager 3 parameter	RECORD
0x1F50	→Program data	ARRAY
0x1F51	→Program control	ARRAY

Continued on next page.

Index	Name	Object code
0x1F56	→Program software identification	ARRAY
0x1F57	→Flash status identification	ARRAY
0x2000	→Node-ID	VAR
0x2001	→CAN bit rate	VAR
0x2002	→RS232 bit rate	VAR
0x2005	→RS232 frame timeout	VAR
0x2006	→USB frame timeout	VAR
0x200A	→CAN bit rate display	VAR
0x2010	→Active fieldbus	VAR
0x2100	→Additional identity	RECORD
0x2101	→Extension 1 identity	RECORD
0x210C	→Custom persistent memory	ARRAY
0x2200	→Power supply	RECORD
0x3000	→Axis configuration	ARRAY
0x3001	→Motor data	RECORD
0x3002	→Electrical system parameters	RECORD
0x3003	→Gear configuration	RECORD
0x3010	→Digital incremental encoder 1	RECORD
0x3011	→Analog incremental encoder	RECORD
0x3012	→SSI absolute encoder	RECORD
0x301A	→Digital Hall sensor	ARRAY
0x3020	→Digital incremental encoder 2	RECORD
0x30A0	→Current control parameter set	RECORD
0x30A1	→Position control parameter set	RECORD
0x30A2	→Velocity control parameter set	RECORD
0x30A3	→Velocity observer parameter set	RECORD
0x30AE	→Dual loop position control parameter set	RECORD
0x30B0	→Home position	VAR
0x30B1	→Home offset move distance	VAR
0x30B2	→Current threshold for homing mode	VAR
0x30D0	→Current demand value	VAR
0x30D1	→Current actual values	ARRAY
0x30D2	→Torque actual values	ARRAY
0x30D3	→Velocity actual values	ARRAY
0x30E0	→Standstill window configuration	RECORD
0x3141	→Digital input properties	ARRAY
0x3142	→Configuration of digital inputs	ARRAY
0x3150	→Digital output properties	ARRAY
0x3151	→Configuration of digital outputs	ARRAY
0x3158	→Holding brake parameters	ARRAY
0x3160	→Analog input properties	ARRAY
0x3163	→Analog input adjustment	REOCDR
0x3180	→Analog output properties	ARRAY
0x3181	→Configuration of analog outputs	ARRAY

Continued on next page.

Index	Name	Object code
0x3182	→Analog output general purpose	ARRAY
0x3200	→Motor protection	RECORD
0x3201	→Thermal controller protection	RECORD
0x6007	→Abort connection option code	VAR
0x603F	→Error code	VAR
0x6040	→Controlword	VAR
0x6041	→Statusword	VAR
0x605A	→Quick stop option code	VAR
0x605B	→Shutdown option code	VAR
0x605C	→Disable operation option code	VAR
0x605E	→Fault reaction option code	VAR
0x6060	→Modes of operation	VAR
0x6061	→Modes of operation display	VAR
0x6062	→Position demand value	VAR
0x6064	→Position actual value	VAR
0x6065	→Following error window	VAR
0x6066	→Following error timeout	VAR
0x606B	→Velocity demand value	VAR
0x606C	→Velocity actual value	VAR
0x6071	→Target torque	VAR
0x6076	→Motor rated torque	VAR
0x6077	→Torque actual value	VAR
0x607A	→Target position	VAR
0x607B	→Position range limit	ARRAY
0x607D	→Software position limit	VAR
0x607F	→Max profile velocity	VAR
0x6080	→Max motor speed	VAR
0x6081	→Profile velocity	VAR
0x6083	→Profile acceleration	VAR
0x6084	→Profile deceleration	VAR
0x6085	→Quick stop deceleration	VAR
0x6086	→Motion profile type	VAR
0x6098	→Homing method	VAR
0x6099	→Homing speeds	ARRAY
0x609A	→Homing acceleration	VAR
0x60A8	→SI unit position	VAR
0x60A9	→SI unit velocity	VAR
0x60AA	→SI unit acceleration	VAR
0x60B0	→Position offset	VAR
0x60B1	→Velocity offset	VAR
0x60B2	→Torque offset	VAR
0x60C2	→Interpolation time period	RECORD
0x60C5	→Max acceleration	VAR
0x60E4	→Additional position actual values	ARRAY

Continued on next page.

Index	Name	Object code
0x60E5	→Additional velocity actual values	ARRAY
0x60F4	→Following error actual value	VAR
0x60FD	→Digital inputs	VAR
0x60FE	→Digital outputs	ARRAY
0x60FF	→Target velocity	VAR
0x6402	→Motor type	VAR
0x6502	→Supported drive modes	VAR
0xF000	→Modular device profile	RECORD
0xF030	→Configured module ident list	ARRAY
0xF050	→Detected module ident list	ARRAY

Table 6-59 Object Dictionary (overview)

6.2 Objects



Annotation

Items marked with an asterisk (*) refer to internal values.

6.2.1 Device type

Describes the device type. The lower word stands for the supported device profile number. The value 0x0192 (402) means that the device follows CiA 402 “CANopen device profile for drives and motion control”. The higher word holds information on the drive type. The value 0x0002 means that the drive is a servo drive.

Name	Device type	
Index	0x1000	
Subindex	0x00	
Data type	UNSIGNED32	
Access type	RO	
Default value	0x00020192	
Value range	–	–
PDO mapping	NO	
Backup	NO	

6.2.2 Error register

The error register for the device. The device maps internal errors in this byte.

Name	Error register	
Index	0x1001	
Subindex	0x00	
Data type	UNSIGNED8	
Access type	RO	
Default value	0	
Value range	–	–
PDO mapping	NO	
Backup	NO	

Bit	Description
7	Motion error
6	reserved (always 0)
5	Device profile-specific
4	Communication error
3	Temperature error
2	Voltage error
1	Current error
0	Generic error

Table 6-60 Error register bits

6.2.3 Error history



The object is only available if the active fieldbus is CANopen.

Holds errors that have occurred on the device and have been signaled via the emergency object.

Name	Error history
Index	0x1003
Object code	ARRAY
Highest subindex supported	5

6.2.3.1 Number of errors

Contains the number of actual errors that are recorded in the array starting at subindex 1. Writing a "0" (zero) deletes the error history (empties the array). Values higher than "0" (zero) are not allowed to write.

Name	Number of errors	
Index	0x1003	
Subindex	0x00	
Data type	UNSIGNED8	
Access type	RW	
Default value	0	
Value range	0	5
PDO mapping	NO	
Backup	NO	

6.2.3.2 Error history

Every new error code is stored at subindex 1, the older ones move down the list. The error numbers compose of a 16-bit error code and 16-bit additional error information that are always zero.

Names	Error history 1 Error history 2 Error history 3 Error history 4 Error history 5	
Index	0x1003	
Subindex	0x01...0x05	
Data type	UNSIGNED32	
Access type	RO	
Default value	-	
Value range	-	-
PDO mapping	NO	
Backup	NO	

6.2.4 COB-ID SYNC

The object is only available if the active fieldbus is CANopen.

The Communication Object Identifier of the synchronization object.

Name	COB-ID SYNC	
Index	0x1005	
Subindex	0x00	
Data type	UNSIGNED32	
Access type	CONST	
Default value	0x00000080	
Value range	–	–
PDO mapping	NO	
Backup	NO	

6.2.4.1 Manufacturer device name

Holds the manufacturer device name.

Name	Manufacturer device name	
Index	0x1008	
Subindex	0x00	
Data type	VISIBLE_STRING	
Access type	RO	
Default value	EPOS4	
Value range	–	–
PDO mapping	NO	
Backup	NO	

6.2.5 Store parameters

Controls saving of configuration parameters in a non-volatile memory.

Name	Store parameters
Index	0x1010
Object code	ARRAY
Highest subindex supported	1

In order to avoid storage of parameters by mistake, storage should only be executed when a specific signature is written to the respective subindex.

On read access, the device will always return the value 0x00000001.

BYTE	MSB			LSB
Character	'e'	'v'	'a'	's'
Hex value	0x65	0x76	0x61	0x73

Table 6-61 Store parameters signature

6.2.5.1 Save all parameters

All parameters of the controller will be stored in a non-volatile memory if the code "save" is written to the object.

Name	Save all parameters
Index	0x1010
Subindex	0x01
Data type	UNSIGNED32
Access type	RW
Default value	0x00000001
Value range	→Table 6-61
PDO mapping	NO
Backup	NO

6.2.6 Restore default parameters

Configuration parameters are restored to the default values.

Restoring the default parameters is permitted in NMT state «Pre-Operational» and device state «Power Disable», only. The default values are only set valid after the device is reset or power cycled.

Name	Restore default parameters
Index	0x1011
Object code	ARRAY
Highest subindex supported	4

In order to avoid restoring of default parameters by mistake, restoring should only be executed when a specific signature is written to the respective subindex.

On read access, the device will always return the value 0x00000001.

BYTE	MSB			LSB
Character	'd'	'a'	'o'	'l'
Hex value	0x64	0x61	0x6F	0x6C

Table 6-62 Restore default parameters signature

6.2.6.1 Restore all default parameters

All parameters of the controller will be stored in a non-volatile memory, if the code "load" is written to the object. Only permitted if all axes of the controller are in device state «Power Disable».

Name	Restore all default parameters
Index	0x1011
Subindex	0x01
Data type	UNSIGNED32
Access type	RW
Default value	0x00000001
Value range	→Table 6-62
PDO mapping	NO
Backup	NO

6.2.7 COB-ID EMCY



The object is only available if the active fieldbus is CANopen.

The Communication Object Identifier of the emergency object.

Name	COB-ID EMCY	
Index	0x1014	
Subindex	0x00	
Data type	UNSIGNED32	
Access type	RO	
Default value	0x00000080 + Node-ID	
Value range	–	–
PDO mapping	NO	
Backup	NO	

6.2.8 Consumer heartbeat time



The object is only available if the active fieldbus is CANopen.

Defines the expected cycle time of the heartbeat. The heartbeat times are higher than the corresponding producer heartbeat times configured on the CANopen device that produces this heartbeat. Monitoring starts after reception of the first heartbeat. The time is given as multiple of 1 ms.

If the heartbeat time is “0” (zero), the Node-ID can also be set to “0” (zero). The object entry will not be used.

We recommend to set the consumer heartbeat time value at least 20 ms higher than the time value of the producer.

Typically, the master (or another slave) produces the heartbeat. Therefore, it does not make sense nor even may work properly if the producer Node-ID configured in this object is equal to the Node-ID in use by this device.

Related objects: → “Producer heartbeat time” on page 6-73

Name	Consumer heartbeat time
Index	0x1016
Object code	ARRAY
Highest subindex supported	2

6.2.8.1 Consumer n heartbeat time

Names	Consumer 1 heartbeat time Consumer 2 heartbeat time
Index	0x1016
Subindex	0x01...0x02
Data type	UNSIGNED32
Access type	RW
Default value	0
Value range	→ Table 6-63
PDO mapping	NO
Backup	YES

Bit 31...24	Bit 23...16	Bit 15...0
reserved (0)	Node-ID	heartbeat time

Table 6-63 Consumer heartbeat time – Structure

6.2.9 Producer heartbeat time



The object is only available if the active fieldbus is CANopen.

Defines the cycle time of the heartbeat. The producer heartbeat time "0" (zero) will not be used. The time must be a multiple of 1 ms.

Name	Producer heartbeat time	
Index	0x1017	
Subindex	0x00	
Data type	UNSIGNED16	
Access type	RW	
Default value	0	
Value range	–	–
PDO mapping	NO	
Backup	YES	

6.2.10 Identity object

Provides general identification information on the device.

Name	Identity object
Index	0x1018
Object code	RECORD
Highest subindex supported	4

6.2.10.1 Vendor-ID

Unique "maxon motor ag" vendor identification defined by CiA.

Name	Vendor-ID	
Index	0x1018	
Subindex	0x01	
Data type	UNSIGNED32	
Access type	RO	
Default value	0x000000FB	
Value range	–	–
PDO mapping	NO	
Backup	NO	

6.2.10.2 Product code

The high word contains the hardware version. The low word contains the application number.

Name	Product code	
Index	0x1018	
Subindex	0x02	
Data type	UNSIGNED32	
Access type	RO	
Default value	–	
Value range	–	–
PDO mapping	NO	
Backup	NO	

Hardware version	Hardware
0x6050	EPOS4 Module 24/1.5 EPOS4 Compact 24/1.5 CAN EPOS4 Compact 24/1.5 EtherCAT
0x6150	EPOS4 Module 50/5 EPOS4 Compact 50/5 CAN EPOS4 Compact 50/5 EtherCAT
0x6551	EPOS4 Module 50/8 EPOS4 Compact 50/8 CAN EPOS4 Compact 50/8 EtherCAT
0x6552	EPOS4 Module 50/15 EPOS4 Compact 50/15 CAN EPOS4 Compact 50/15 EtherCAT
0x6350	EPOS4 50/5
0x6450	EPOS4 70/15

Table 6-64 Definition of hardware version

6.2.10.3 Revision number

The high word contains the software version. The low word contains the application version.

Name	Revision number	
Index	0x1018	
Subindex	0x03	
Data type	UNSIGNED32	
Access type	RO	
Default value	–	
Value range	–	–
PDO mapping	NO	
Backup	NO	

6.2.10.4 Serial number

Contains the last 8 digits of the device serial number.

Related objects: → "Serial number complete" on page 6-127

Name	Serial number	
Index	0x1018	
Subindex	0x04	
Data type	UNSIGNED32	
Access type	RO	
Default value	–	
Value range	–	–
PDO mapping	NO	
Backup	NO	

6.2.11 Diagnosis history

The object is only available if the active fieldbus is EtherCAT.

Allows the EtherCAT master to access the latest diagnosis messages. Up to maximal five diagnosis messages can be accessed.

In case of an error, the corresponding message will be displayed in «TwinCAT» (tab "Diag History") and in «EPOS Studio». The error may be cleared by writing the value 0x80 to the → "Controlword" on page 6-199.

Name	Diagnosis history	
Index	0x10F3	
Object code	RECORD	
Highest subindex supported	10	

6.2.11.1 Maximum messages

Represents the number of diagnosis messages that can be stored in the diagnosis history (subindex 6 onwards).

Name	Maximum messages	
Index	0x10F3	
Subindex	0x01	
Data type	UNSIGNED8	
Access type	RO	
Default value	5	
Value range	5	5
PDO mapping	NO	
Backup	NO	

6.2.11.2 *Newest message*

The subindex of the latest diagnosis message (6...255).

Name	Newest message	
Index	0x10F3	
Subindex	0x02	
Data type	UNSIGNED8	
Access type	RO	
Default value	0	
Value range	0, 6	10
PDO mapping	NO	
Backup	NO	

6.2.11.3 *Newest acknowledged message*

Name	Newest acknowledged message	
Index	0x10F3	
Subindex	0x03	
Data type	UNSIGNED8	
Access type	RW	
Default value	0	
Value range	0	255
PDO mapping	NO	
Backup	NO	

Bit	RW	Description
255...[SI0]	W	SDO abort with codes 0x06090030 (value range of parameter exceeded) or 0x06090031 (value of parameter too high)
6...[SI0]	W	SI3 = written value without checking
5...1	W	The Slave returns SDO abort with codes 0x06090030 (value range of parameter exceeded) or 0x06090032 (value of parameter too low)
0	R	When the message queue will be overwritten, the Slave sets SI3 to "0" (zero)
	W	The Slave will clear all messages

Table 6-65 Newest acknowledged message – Read/Write bits

6.2.11.4 *New messages available*

Name	New messages available	
Index	0x10F3	
Subindex	0x04	
Data type	BOOLEAN	
Access type	RO	
Default value	0	
Value range	0 (newest message was read)	1 (newest message was not read)
PDO mapping	YES	
Backup	NO	

6.2.11.5 Flags

Flags the diagnosis messages for sending/storing. The ESI/SII describes the functionality supported by the Slave. If the Master writes an unsupported value, the Slave returns 0x06090030 (value range of parameter exceeded).

Name	Flags	
Index	0x10F3	
Subindex	0x05	
Data type	UNSIGNED16	
Access type	R(W)	
Default value	0	
Value range	0	15
PDO mapping	NO	
Backup	NO	

Bit		RW	Description
15...6	–	–	reserved
5	1	RO	<ul style="list-style-type: none"> In Overwrite Mode: Unacknowledged messages have been overwritten; SI3 is set to "0" (zero) In Acknowledge Mode: Buffer is full with unacknowledged messages, new messages are discarded
4	0	(W)	Overwrite Mode – old messages are overwritten if buffer is full
	1		Acknowledge Mode – new messages only overwrites older ones if before acknowledged
3	0	(W)	Error messages are stored in the diagnosis message queue
	1		Error messages will not be stored in the diagnosis message queue
2	0	W	Warning messages are stored in the diagnosis message queue
	1		Warning messages will not be stored in the diagnosis message queue
1	0	W	Info messages are stored in the diagnosis message queue
	1		Info messages will not be stored in the diagnosis message queue
0	0	(W)	Default if device does not support Emergency Sending
	1		New diagnosis messages are sent as Emergency Message

Table 6-66 Flags – Read/Write bits

6.2.11.6 Diagnosis message

The buffer can store up to 5 diagnosis messages. The first message is stored in subindex 6, the next in subindex 7, and so on. Once the diagnosis message queue is full, the Slave overwrites subindex 6, then subindex 7, and so on, thus enabling the Master to access the most recent messages).

Name	Diagnosis message	
Index	0x10F3	
Subindex	0x06...0x0A	
Data type	OCTET_STRING	
Access type	R	
Default value	–	
Value range	–	–
PDO mapping	NO	
Backup	NO	

6.2.12 SDO server parameter



The object is only available if the active fieldbus is CANopen.

Name	SDO server parameter
Index	0x1200
Object code	RECORD
Highest subindex supported	2

6.2.12.1 COB-ID SDO client to server

Shows the Communication Object Identifier for service data objects from master to device.

Related objects: → “Producer heartbeat time” on page 6-73

Name	COB-ID SDO client to server	
Index	0x1200	
Subindex	0x01	
Data type	UNSIGNED32	
Access type	RO	
Default value	0x00000600 + Node-ID	
Value range	–	–
PDO mapping	NO	
Backup	NO	

6.2.12.2 COB-ID SDO server to client

Shows the Communication Object Identifier for service data objects from device to master.

Related objects: → “Node-ID” on page 6-123

Name	COB-ID SDO server to client	
Index	0x1200	
Subindex	0x02	
Data type	UNSIGNED32	
Access type	RO	
Default value	0x00000580 + Node-ID	
Value range	–	–
PDO mapping	NO	
Backup	NO	

6.2.13 Receive PDO 1 parameter



The object is only available if the active fieldbus is CANopen.

Name	Receive PDO 1 parameter
Index	0x1400
Object code	RECORD
Highest subindex supported	2

6.2.13.1 COB-ID used by RxPDO 1

The Communication Object Identifier of receive process data object.

Name	COB-ID used by RxPDO 1
Index	0x1400
Subindex	0x01
Data type	UNSIGNED32
Access type	RW
Default value	0x00000200 + Node-ID
Value range	→ Table 6-67 and Table 6-68
PDO mapping	NO
Backup	YES

Bit 31	Bit 30	Bit 29...11	Bit 10...0
valid	RTR	0 (CAN base frame)	11-bit CAN ID

Table 6-67 COB-ID used by RxPDO – Structure

Bit	Description	
valid	0b	PDO exists / PDO is valid
	1b	PDO does not exist / PDO is not valid
RTR	0b	RTR allowed on this PDO
	1b	no RTR allowed on this PDO
11-bit Can ID	Value range	0x181...0x57F 0x000 (if valid = 1)

Table 6-68 COB-ID used by RxPDO – Description

6.2.13.2 Transmission type RxPDO 1

Describes the PDO's communication principle.

Name	Transmission type RxPDO 1	
Index	0x1400	
Subindex	0x02	
Data type	UNSIGNED8	
Access type	RW	
Default value	255	
Value range	1:synchronous 255:asynchronous	-
PDO mapping	NO	
Backup	YES	

6.2.14 Receive PDO 2 parameter



The object is only available if the active fieldbus is CANopen.

Name	Receive PDO 2 parameter
Index	0x1401
Object code	RECORD
Highest subindex supported	2

6.2.14.1 COB-ID used by RxPDO 2

The Communication Object Identifier of receive process data object.

Name	COB-ID used by RxPDO 2
Index	0x1401
Subindex	0x01
Data type	UNSIGNED32
Access type	RW
Default value	0x00000300 + Node-ID
Value range	→ Table 6-67 and Table 6-68
PDO mapping	NO
Backup	YES

6.2.14.2 Transmission type RxPDO 2

Describes the PDO's communication principle.

Name	Transmission type RxPDO 2	
Index	0x1401	
Subindex	0x02	
Data type	UNSIGNED8	
Access type	RW	
Default value	255	
Value range	1:synchronous 255:asynchronous	–
PDO mapping	NO	
Backup	YES	

6.2.15 Receive PDO 3 parameter



The object is only available if the active fieldbus is CANopen.

Name	Receive PDO 3 parameter
Index	0x1402
Object code	RECORD
Highest subindex supported	2

6.2.15.1 COB-ID used by RxPDO 3

The Communication Object Identifier of receive process data object.

Name	COB-ID used by RxPDO 3
Index	0x1402
Subindex	0x01
Data type	UNSIGNED32
Access type	RW
Default value	0x00000400 + Node-ID
Value range	→ Table 6-67 and Table 6-68
PDO mapping	NO
Backup	YES

6.2.15.2 Transmission type RxPDO 3

Describes the PDO's communication principle.

Name	Transmission type RxPDO 3
Index	0x1402
Subindex	0x02
Data type	UNSIGNED8
Access type	RW
Default value	255
Value range	1:synchronous 255:asynchronous
PDO mapping	NO
Backup	YES

6.2.16 Receive PDO 4 parameter



The object is only available if the active fieldbus is CANopen.

Name	Receive PDO 4 parameter
Index	0x1403
Object code	RECORD
Highest subindex supported	2

6.2.16.1 COB-ID used by RxPDO 4

The Communication Object Identifier of receive process data object.

Name	COB-ID used by RxPDO 4
Index	0x1403
Subindex	0x01
Data type	UNSIGNED32
Access type	RW
Default value	0x00000500 + Node-ID
Value range	→ Table 6-67 and Table 6-68
PDO mapping	NO
Backup	YES

6.2.16.2 Transmission type RxPDO 4

Describes the PDO's communication principle.

Name	Transmission type RxPDO 4	
Index	0x1403	
Subindex	0x02	
Data type	UNSIGNED8	
Access type	RW	
Default value	255	
Value range	1:synchronous 255:asynchronous	–
PDO mapping	NO	
Backup	YES	

6.2.17 Receive PDO 1 mapping

Contains the process data mapping parameters of RxPDO1. Mapping of objects is required to enable PDO processing. Subindex 0 represents the number of mapped objects. Subindex 0x01...0x0C represent the mapped objects whereby the value describes the corresponding index, subindex, and length. The value for the length (in bits) is used to calculate the total mapping length. The maximal allowed length for all mapped objects is as follows:

- CANopen 8 Byte
- EtherCAT 40 Byte

Write access is only permitted in NMT state «Pre-Operational».

The structure for the mapped object in subindex 0x01...0x0C is as follows:

Bit 31...16	Bit 15...8	Bit 7...0
Index	Subindex	Length

Table 6-69 Receive PDO mapping – Structure of mapped object

To be able to change the PDO mapping, the following procedure must be performed:

- a) Write the value "0" (zero) to subindex 0x00 (disable PDO).
- b) Modify the desired objects in subindex 0x01...0x0n.
- c) Write the desired number of mapped objects to subindex 0x00.

Name	Receive PDO 1 mapping
Index	0x1600
Object code	RECORD
Highest subindex supported	12

6.2.17.1 Number of mapped objects in RxPDO 1

Name	Number of mapped objects in RxPDO 1	
Index	0x1600	
Subindex	0x00	
Data type	UNSIGNED8	
Access type	RW	
Default value	1	
Value range	0 (PDO disabled)	1...12 (1...12 objects are mapped)
PDO mapping	NO	
Backup	YES	

6.2.17.2 1st mapped object in RxPDO 1

Objects with subindex 0x02...0x0C follow the same description as the object with subindex 1.

Name	1st mapped object in RxPDO 1	
Index	0x1600	
Subindex	0x01	
Data type	UNSIGNED32	
Access type	RW	
Default value	0x60400010	
Value range	–	–
PDO mapping	NO	
Backup	YES	

DEFAULT VALUES FOR MAPPED OBJECTS IN RxPDO1

Mapped object	Subindex	Default value	
1 st	0x01	0x60400010	→Controlword
2 nd	0x02	0x00000000	no object mapped
3 rd	0x03	0x00000000	no object mapped
4 th	0x04	0x00000000	no object mapped
5 th	0x05	0x00000000	no object mapped
6 th	0x06	0x00000000	no object mapped
7 th	0x07	0x00000000	no object mapped
8 th	0x08	0x00000000	no object mapped
9 th	0x09	0x00000000	no object mapped
10 th	0x0A	0x00000000	no object mapped
11 th	0x0B	0x00000000	no object mapped
12 th	0x0C	0x00000000	no object mapped

Table 6-70 Receive PDO 1 mapping

6.2.18 Receive PDO 2 mapping

Contains the process data mapping parameters of RxPDO2. For a detailed description applicable by analogy → "Receive PDO 1 mapping" on page 6-84.

Name	Receive PDO 2 mapping
Index	0x1601
Object code	RECORD
Highest subindex supported	12

6.2.18.1 Number of mapped objects in RxPDO 2

Name	Number of mapped objects in RxPDO 2	
Index	0x1601	
Subindex	0x00	
Data type	UNSIGNED8	
Access type	RW	
Default value	2	
Value range	0 (PDO disabled)	1...12 (1...12 objects are mapped)
PDO mapping	NO	
Backup	YES	

6.2.18.2 1st mapped object in RxPDO 2

Objects with subindex 0x02...0x12 follow the same description as the object with subindex 1.

Name	1st mapped object in RxPDO 2	
Index	0x1601	
Subindex	0x01	
Data type	UNSIGNED32	
Access type	RW	
Default value	0x60400010	
Value range	–	–
PDO mapping	NO	
Backup	YES	

DEFAULT VALUES FOR MAPPED OBJECTS IN RXPDO2

Mapped object	Subindex	Default value	
1 st	0x01	0x60400010	→Controlword
2 nd	0x02	0x60600008	→Modes of operation
3 rd	0x03	0x00000000	no object mapped
4 th	0x04	0x00000000	no object mapped
5 th	0x05	0x00000000	no object mapped
6 th	0x06	0x00000000	no object mapped
7 th	0x07	0x00000000	no object mapped
8 th	0x08	0x00000000	no object mapped
9 th	0x09	0x00000000	no object mapped
10 th	0x0A	0x00000000	no object mapped
11 th	0x0B	0x00000000	no object mapped
12 th	0x0C	0x00000000	no object mapped

Table 6-71 Receive PDO 2 mapping

6.2.19 Receive PDO 3 mapping

Contains the process data mapping parameters of RxPDO3. For a detailed description applicable by analogy → “Receive PDO 1 mapping” on page 6-84.

Name	Receive PDO 3 mapping
Index	0x1602
Object code	RECORD
Highest subindex supported	12

6.2.19.1 Number of mapped objects in RxPDO 3

Name	Number of mapped objects in RxPDO 3	
Index	0x1602	
Subindex	0x00	
Data type	UNSIGNED8	
Access type	RW	
Default value	2	
Value range	0 (PDO disabled)	1...12 (1...12 objects are mapped)
PDO mapping	NO	
Backup	YES	

6.2.19.2 1st mapped object in RxPDO 3

Objects with subindex 0x02...0x12 follow the same description as the object with subindex 1.

Name	1st mapped object in RxPDO 3	
Index	0x1602	
Subindex	0x01	
Data type	UNSIGNED32	
Access type	RW	
Default value	0x60400010	
Value range	–	–
PDO mapping	NO	
Backup	YES	

DEFAULT VALUES FOR MAPPED OBJECTS IN RxPDO3

Mapped object	Subindex	Default value	
1 st	0x01	0x60400010	→Controlword
2 nd	0x02	0x607A0020	→Target position
3 rd	0x03	0x00000000	no object mapped
4 th	0x04	0x00000000	no object mapped
5 th	0x05	0x00000000	no object mapped
6 th	0x06	0x00000000	no object mapped
7 th	0x07	0x00000000	no object mapped
8 th	0x08	0x00000000	no object mapped
9 th	0x09	0x00000000	no object mapped
10 th	0x0A	0x00000000	no object mapped
11 th	0x0B	0x00000000	no object mapped
12 th	0x0C	0x00000000	no object mapped

Table 6-72 Receive PDO 3 mapping

6.2.20 Receive PDO 4 mapping

Contains the process data mapping parameters of RxPDO4. For a detailed description applicable by analogy → “Receive PDO 1 mapping” on page 6-84.

Name	Receive PDO 4 mapping
Index	0x1603
Object code	RECORD
Highest subindex supported	12

6.2.20.1 Number of mapped objects in RxPDO 4

Name	Number of mapped objects in RxPDO 4	
Index	0x1603	
Subindex	0x00	
Data type	UNSIGNED8	
Access type	RW	
Default value	2	
Value range	0 (PDO disabled)	1...12 (1...12 objects are mapped)
PDO mapping	NO	
Backup	YES	

6.2.20.2 1st mapped object in RxPDO 4

Objects with subindex 0x02...0x12 follow the same description as the object with subindex 1.

Name	1st mapped object in RxPDO 4	
Index	0x1603	
Subindex	0x01	
Data type	UNSIGNED32	
Access type	RW	
Default value	0x60400010	
Value range	–	–
PDO mapping	NO	
Backup	YES	

DEFAULT VALUES FOR MAPPED OBJECTS IN RXPDO4

Mapped object	Subindex	Default value	
1 st	0x01	0x60400010	→Controlword
2 nd	0x02	0x60FF0020	→Target velocity
3 rd	0x03	0x00000000	no object mapped
4 th	0x04	0x00000000	no object mapped
5 th	0x05	0x00000000	no object mapped
6 th	0x06	0x00000000	no object mapped
7 th	0x07	0x00000000	no object mapped
8 th	0x08	0x00000000	no object mapped
9 th	0x09	0x00000000	no object mapped
10 th	0x0A	0x00000000	no object mapped
11 th	0x0B	0x00000000	no object mapped
12 th	0x0C	0x00000000	no object mapped

Table 6-73 Receive PDO 4 mapping

6.2.21 Transmit PDO 1 parameter



The object is only available if the active fieldbus is CANopen.

Name	Transmit PDO 1 parameter
Index	0x1800
Object code	RECORD
Highest subindex supported	3

6.2.21.1 COB-ID used by TxPDO 1

The Communication Object Identifier of transmit process data object.

Name	COB-ID used by TxPDO 1
Index	0x1800
Subindex	0x01
Data type	UNSIGNED32
Access type	RW
Default value	0x40000180 + Node-ID
Value range	→ Table 6-74 and Table 6-75
PDO mapping	NO
Backup	YES

Bit 31	Bit 30	Bit 29...11	Bit 10...0
valid	RTR	0 (CAN base frame)	11-bit CAN ID

Table 6-74 COB-ID used by TxPDO – Structure

Bit	Description	
valid	0b	PDO exists / PDO is valid
	1b	PDO does not exist / PDO is not valid
RTR	0b	RTR allowed on this PDO
	1b	no RTR allowed on this PDO
11-bit Can ID	11-bit CAN ID of the CAN base frame	
	Value range	0x181...0x57F 0x000 (if valid = 1)

Table 6-75 COB-ID used by TxPDO – Description

6.2.21.2 Transmission type TxPDO 1

Describes the PDO's communication principle.

With transmission type 253, the PDO is only transmitted on remote transmission request (RTR). With transmission type 255, the PDO is transmitted if the data changes its value. Therefore, the inhibit time defines a minimum interval.

Name	Transmission type TxPDO 1	
Index	0x1800	
Subindex	0x02	
Data type	UNSIGNED8	
Access type	RW	
Default value	255	
Value range	1: synchronous 253: asynchronous on RTR only 255: asynchronous	–
PDO mapping	NO	
Backup	YES	

6.2.21.3 Inhibit time TxPDO 1

Represents the minimum interval for event-triggered PDO transmission. The value is defined as multiple of 100 μ s.

Event-triggered PDOs can generate immense loads on both CAN bus and device especially if the inhibit time of different PDOs is set to a small value.

Name	Inhibit time TxPDO 1	
Index	0x1800	
Subindex	0x03	
Data type	UNSIGNED16	
Access type	RW	
Default value	10	
Value range	–	–
PDO mapping	NO	
Backup	YES	

6.2.22 Transmit PDO 2 parameter



The object is only available if the active fieldbus is CANopen.

Name	Transmit PDO 2 parameter
Index	0x1801
Object code	RECORD
Highest subindex supported	3

6.2.22.1 COB-ID used by TxPDO 2

The Communication Object Identifier of transmit process data object.

Name	COB-ID used by TxPDO 2
Index	0x1801
Subindex	0x01
Data type	UNSIGNED32
Access type	RW
Default value	0xC0000280 + Node-ID
Value range	→ Table 6-74 and Table 6-75
PDO mapping	NO
Backup	YES

6.2.22.2 Transmission type TxPDO 2

Describes the PDO's communication principle.

With transmission type 253, the PDO is only transmitted on remote transmission request (RTR). With transmission type 255, the PDO is transmitted if the data changes its value. Therefore, the inhibit time defines a minimum interval.

Name	Transmission type TxPDO 2	
Index	0x1801	
Subindex	0x02	
Data type	UNSIGNED8	
Access type	RW	
Default value	255	
Value range	1: synchronous 253: asynchronous on RTR only 255: asynchronous	–
PDO mapping	NO	
Backup	YES	

6.2.22.3 Inhibit time TxPDO 2

Represents the minimum interval for event-triggered PDO transmission. The value is defined as multiple of 100 μ s.

Event-triggered PDOs can generate immense loads on both CAN bus and device especially if the inhibit time of different PDOs is set to a small value.

Name	Inhibit time TxPDO 2	
Index	0x1801	
Subindex	0x03	
Data type	UNSIGNED16	
Access type	RW	
Default value	10	
Value range	–	–
PDO mapping	NO	
Backup	YES	

6.2.23 Transmit PDO 3 parameter



The object is only available if the active fieldbus is CANopen.

Name	Transmit PDO 3 parameter
Index	0x1802
Object code	RECORD
Highest subindex supported	3

6.2.23.1 COB-ID used by TxPDO 3

The Communication Object Identifier of transmit process data object.

Name	COB-ID used by TxPDO 3
Index	0x1802
Subindex	0x01
Data type	UNSIGNED32
Access type	RW
Default value	0xC0000380 + Node-ID
Value range	→ Table 6-74 and Table 6-75
PDO mapping	NO
Backup	YES

6.2.23.2 Transmission type TxPDO 3

Describes the PDO's communication principle.

With transmission type 253, the PDO is only transmitted on remote transmission request (RTR). With transmission type 255, the PDO is transmitted if the data changes its value. Therefore, the inhibit time defines a minimum interval.

Name	Transmission type TxPDO 3	
Index	0x1802	
Subindex	0x02	
Data type	UNSIGNED8	
Access type	RW	
Default value	255	
Value range	1: synchronous 253: asynchronous on RTR only 255: asynchronous	–
PDO mapping	NO	
Backup	YES	

6.2.23.3 Inhibit time TxPDO 3

Represents the minimum interval for event-triggered PDO transmission. The value is defined as multiple of 100 μ s.

Event-triggered PDOs can generate immense loads on both CAN bus and device especially if the inhibit time of different PDOs is set to a small value.

Name	Inhibit time TxPDO 3	
Index	0x1802	
Subindex	0x03	
Data type	UNSIGNED16	
Access type	RW	
Default value	10	
Value range	–	–
PDO mapping	NO	
Backup	YES	

6.2.24 Transmit PDO 4 parameter



The object is only available if the active fieldbus is CANopen.

Name	Transmit PDO 4 parameter
Index	0x1803
Object code	RECORD
Highest subindex supported	3

6.2.24.1 COB-ID used by TxPDO 4

The Communication Object Identifier of transmit process data object.

Name	COB-ID used by TxPDO 4
Index	0x1803
Subindex	0x01
Data type	UNSIGNED32
Access type	RW
Default value	0xC0000480 + Node-ID
Value range	→ Table 6-74 and Table 6-75
PDO mapping	NO
Backup	YES

6.2.24.2 Transmission type TxPDO 4

Describes the PDO's communication principle.

With transmission type 253, the PDO is only transmitted on remote transmission request (RTR). With transmission type 255, the PDO is transmitted if the data changes its value. Therefore, the inhibit time defines a minimum interval.

Name	Transmission type TxPDO 4	
Index	0x1803	
Subindex	0x02	
Data type	UNSIGNED8	
Access type	RW	
Default value	255	
Value range	1: synchronous 253: asynchronous on RTR only 255: asynchronous	–
PDO mapping	NO	
Backup	YES	

6.2.24.3 Inhibit time TxPDO 4

Represents the minimum interval for event-triggered PDO transmission. The value is defined as multiple of 100 μ s.

Event-triggered PDOs can generate immense loads on both CAN bus and device especially if the inhibit time of different PDOs is set to a small value.

Name	Inhibit time TxPDO 4	
Index	0x1803	
Subindex	0x03	
Data type	UNSIGNED16	
Access type	RW	
Default value	10	
Value range	–	–
PDO mapping	NO	
Backup	YES	

6.2.25 Transmit PDO 1 mapping

Contains the process data mapping parameters of TxPDO1. Mapping of objects is required to enable PDO processing. Subindex 0 represents the number of mapped objects. Subindex 0x01...0x0C represent the mapped objects whereby the value describes the corresponding index, subindex, and length. The value for the length (in bits) is used to calculate the total mapping length.

The maximal allowed length for all mapped objects is as follows:

- CANopen 8 Byte
- EtherCAT 40 Byte

Write access is only permitted in NMT state «Pre-Operational».

The structure for the mapped object in subindex 0x01...0x0C is as follows:

Bit 31...16	Bit 15...8	Bit 7...0
Index	Subindex	Length

Table 6-76 Transmit PDO mapping – Structure of mapped object

To be able to change the PDO mapping, the following procedure must be performed:

- a) Write the value "0" (zero) to subindex 0x00 (disable PDO).
- b) Modify the desired objects in subindex 0x01...0x0n.
- c) Write the desired number of mapped objects to subindex 0x00.

Name	Transmit PDO 1 mapping
Index	0x1A00
Object code	RECORD
Highest subindex supported	12

6.2.25.1 Number of mapped objects in TxPDO 1

Name	Number of mapped objects in TxPDO 1	
Index	0x1A00	
Subindex	0x00	
Data type	UNSIGNED8	
Access type	RW	
Default value	1	
Value range	0 (PDO disabled)	1...12 (1...12 objects are mapped)
PDO mapping	NO	
Backup	YES	

6.2.25.2 1st mapped object in TxPDO 1

Objects with subindex 0x02...0x0C follow the same description as the object with subindex 1.

Name	1st mapped object in TxPDO 1	
Index	0x1A00	
Subindex	0x01	
Data type	UNSIGNED32	
Access type	RW	
Default value	0x60410010	
Value range	–	–
PDO mapping	NO	
Backup	YES	

DEFAULT VALUES FOR MAPPED OBJECTS IN TxPDO1

Mapped object	Subindex	Default value	
1 st	0x01	0x60410010	→ Statusword
2 nd	0x02	0x00000000	no object mapped
3 rd	0x03	0x00000000	no object mapped
4 th	0x04	0x00000000	no object mapped
5 th	0x05	0x00000000	no object mapped
6 th	0x06	0x00000000	no object mapped
7 th	0x07	0x00000000	no object mapped
8 th	0x08	0x00000000	no object mapped
9 th	0x09	0x00000000	no object mapped
10 th	0x0A	0x00000000	no object mapped
11 th	0x0B	0x00000000	no object mapped
12 th	0x0C	0x00000000	no object mapped

Table 6-77 Transmit PDO 1 mapping

6.2.26 Transmit PDO 2 mapping

Contains the process data mapping parameters of TxPDO2. For a detailed description applicable by analogy → “Transmit PDO 1 mapping” on page 6-100.

Name	Transmit PDO 2 mapping
Index	0x1A01
Object code	RECORD
Highest subindex supported	12

6.2.26.1 Number of mapped objects in TxPDO 2

Name	Number of mapped objects in TxPDO 2	
Index	0x1A01	
Subindex	0x00	
Data type	UNSIGNED8	
Access type	RW	
Default value	2	
Value range	0 (PDO disabled)	1...12 (1...12 objects are mapped)
PDO mapping	NO	
Backup	YES	

6.2.26.2 1st mapped object in TxPDO 2

Objects with subindex 0x02...0x0C follow the same description as the object with subindex 1.

Name	1st mapped object in TxPDO 2	
Index	0x1A01	
Subindex	0x01	
Data type	UNSIGNED32	
Access type	RW	
Default value	0x60410010	
Value range	–	–
PDO mapping	NO	
Backup	YES	

DEFAULT VALUES FOR MAPPED OBJECTS IN TxPDO2

Mapped object	Subindex	Default value	
1 st	0x01	0x60410010	→ Statusword
2 nd	0x02	0x60610008	→ Modes of operation display
3 rd	0x03	0x00000000	no object mapped
4 th	0x04	0x00000000	no object mapped
5 th	0x05	0x00000000	no object mapped
6 th	0x06	0x00000000	no object mapped
7 th	0x07	0x00000000	no object mapped
8 th	0x08	0x00000000	no object mapped
9 th	0x09	0x00000000	no object mapped
10 th	0x0A	0x00000000	no object mapped
11 th	0x0B	0x00000000	no object mapped
12 th	0x0C	0x00000000	no object mapped

Table 6-78 Transmit PDO 2 mapping

6.2.27 Transmit PDO 3 mapping

Contains the process data mapping parameters of TxPDO3. For a detailed description applicable by analogy → “Transmit PDO 1 mapping” on page 6-100.

Name	Transmit PDO 3 mapping
Index	0x1A02
Object code	RECORD
Highest subindex supported	12

6.2.27.1 Number of mapped objects in TxPDO 3

Name	Number of mapped objects in TxPDO 3	
Index	0x1A02	
Subindex	0x00	
Data type	UNSIGNED8	
Access type	RW	
Default value	2	
Value range	0 (PDO disabled)	1...12 (1...12 objects are mapped)
PDO mapping	NO	
Backup	YES	

6.2.27.2 1st mapped object in TxPDO 3

Objects with subindex 0x02...0x0C follow the same description as the object with subindex 1.

Name	1st mapped object in TxPDO 3	
Index	0x1A02	
Subindex	0x01	
Data type	UNSIGNED32	
Access type	RW	
Default value	0x60410010	
Value range	–	–
PDO mapping	NO	
Backup	YES	

DEFAULT VALUES FOR MAPPED OBJECTS IN TxPDO3

Mapped object	Subindex	Default value	
1 st	0x01	0x60410010	→ Statusword
2 nd	0x02	0x60640020	→ Position actual value
3 rd	0x03	0x00000000	no object mapped
4 th	0x04	0x00000000	no object mapped
5 th	0x05	0x00000000	no object mapped
6 th	0x06	0x00000000	no object mapped
7 th	0x07	0x00000000	no object mapped
8 th	0x08	0x00000000	no object mapped
9 th	0x09	0x00000000	no object mapped
10 th	0x0A	0x00000000	no object mapped
11 th	0x0B	0x00000000	no object mapped
12 th	0x0C	0x00000000	no object mapped

Table 6-79 Transmit PDO 3 mapping

6.2.28 Transmit PDO 4 mapping

Contains the process data mapping parameters of TxPDO4. For a detailed description applicable by analogy → “Transmit PDO 1 mapping” on page 6-100.

Name	Transmit PDO 4 mapping
Index	0x1A03
Object code	RECORD
Highest subindex supported	12

6.2.28.1 Number of mapped objects in TxPDO 4

Name	Number of mapped objects in TxPDO 4	
Index	0x1A03	
Subindex	0x00	
Data type	UNSIGNED8	
Access type	RW	
Default value	2	
Value range	0 (PDO disabled)	1...12 (1...12§ objects are mapped)
PDO mapping	NO	
Backup	YES	

6.2.28.2 1st mapped object in TxPDO 4

Objects with subindex 0x02...0x0C follow the same description as the object with subindex 1.

Name	1st mapped object in TxPDO 4	
Index	0x1A03	
Subindex	0x01	
Data type	UNSIGNED32	
Access type	RW	
Default value	0x60410010	
Value range	–	–
PDO mapping	NO	
Backup	YES	

DEFAULT VALUES FOR MAPPED OBJECTS IN TxPDO4

Mapped object	Subindex	Default value	
1 st	0x01	0x60410010	→ Statusword
2 nd	0x02	0x606C0020	→ Velocity actual value
3 rd	0x03	0x00000000	no object mapped
4 th	0x04	0x00000000	no object mapped
5 th	0x05	0x00000000	no object mapped
6 th	0x06	0x00000000	no object mapped
7 th	0x07	0x00000000	no object mapped
8 th	0x08	0x00000000	no object mapped
9 th	0x09	0x00000000	no object mapped
10 th	0x0A	0x00000000	no object mapped
11 th	0x0B	0x00000000	no object mapped
12 th	0x0C	0x00000000	no object mapped

Table 6-80 Transmit PDO 4 mapping

6.2.29 SYNC manager communication type



The object is only available if the active fieldbus is EtherCAT.

The preconfigured read only object is used to read out the transfer mode of the EtherCAT Sync Manager's channels.

Name	SYNC manager communication type
Index	0x1C00
Object code	ARRAY
Highest subindex supported	4

6.2.29.1 Number of used SYNC manager channels

Name	Number of used SYNC manager channels	
Index	0x1C00	
Subindex	0x00	
Data type	UNSIGNED8	
Access type	RO	
Default value	4	
Value range	4	4
PDO mapping	NO	
Backup	NO	

6.2.29.2 Communication type SYNC channel 0

Name	Communication type SYNC channel 0	
Index	0x1C00	
Subindex	0x01	
Data type	UNSIGNED8	
Access type	RO	
Default value	1: Mailbox Receive (Master → Slave)	
Value range	1	1
PDO mapping	NO	
Backup	NO	

6.2.29.3 Communication type SYNC channel 1

Name	Communication type SYNC channel 1	
Index	0x1C00	
Subindex	0x02	
Data type	UNSIGNED8	
Access type	RO	
Default value	2: Mailbox Receive (Master ← Slave)	
Value range	2	2
PDO mapping	NO	
Backup	NO	

6.2.29.4 Communication type SYNC channel 2

Name	Communication type SYNC channel 2	
Index	0x1C00	
Subindex	0x03	
Data type	UNSIGNED8	
Access type	RO	
Default value	3: Process Data Output (Master → Slave)	
Value range	3	3
PDO mapping	NO	
Backup	NO	

6.2.29.5 Communication type SYNC channel 3

Name	Communication type SYNC channel 3	
Index	0x1C00	
Subindex	0x04	
Data type	UNSIGNED8	
Access type	RO	
Default value	4: Process Data Output (Master ← Slave)	
Value range	4	4
PDO mapping	NO	
Backup	NO	

6.2.30 SYNC manager 2 PDO assignment



The object is only available if the active fieldbus is EtherCAT.

Used to configure a PDO assignment for Sync channel 2 (Master → Slave).

In order to change the value in object → 1st assigned RxPDO, object → Number of assigned RxPDOs must be set to zero first.

Write access is only permitted in NMT state «Pre-Operational».

Name	SYNC manager 2 PDO assignment
Index	0x1C12
Object code	ARRAY
Highest subindex supported	1

6.2.30.1 Number of assigned RxPDOs

Name	Number of assigned RxPDOs	
Index	0x1C12	
Subindex	0x00	
Data type	UNSIGNED8	
Access type	RW	
Default value	1	
Value range	0 (PDO disabled)	1
PDO mapping	NO	
Backup	YES	

6.2.30.2 1st assigned RxPDO

Name	1st assigned RxPDO	
Index	0x1C12	
Subindex	0x01	
Data type	UNSIGNED16	
Access type	RW	
Default value	0x1600	
Value range	0x1600	0x1603
PDO mapping	NO	
Backup	YES	

6.2.31 SYNC manager 3 PDO assignment



The object is only available if the active fieldbus is EtherCAT.

Used to configure a PDO assignment for Sync channel 2 (Master ← Slave).

In order to change the value in object → 1st assigned TxPDO, object → Number of assigned TxPDOs must be set to zero first.

Write access is only permitted in NMT state «Pre-Operational».

Name	SYNC manager 3 PDO assignment
Index	0x1C13
Object code	ARRAY
Highest subindex supported	1

6.2.31.1 Number of assigned TxPDOs

Name	Number of assigned TxPDOs	
Index	0x1C13	
Subindex	0x00	
Data type	UNSIGNED8	
Access type	RW	
Default value	1	
Value range	0 (PDO disabled)	1
PDO mapping	NO	
Backup	YES	

6.2.31.2 1st assigned TxPDO

Name	1st assigned TxPDO	
Index	0x1C13	
Subindex	0x01	
Data type	UNSIGNED16	
Access type	RW	
Default value	0x1A00	
Value range	0x1A00	0x1A03
PDO mapping	NO	
Backup	YES	

6.2.32 SYNC manager 2 parameter



The object is only available if the active fieldbus is EtherCAT.

Used to display the synchronization of the output parameters.

Name	SYNC manager 2 parameter
Index	0x1C32
Object code	RECORD
Highest subindex supported	12

6.2.32.1 Synchronization type

Displays the synchronization type of the output parameters.

Name	Synchronization type
Index	0x1C32
Subindex	0x01
Data type	UNSIGNED16
Access type	RO
Default value	Synchronous
Value range	→ Table 6-81
PDO mapping	NO
Backup	NO

Value	Description
0x0001	Synchronous: Synchronous (with SM2 event)
0x0002	Distributed clock Sync0: Synchronous with SYNC0 event

Table 6-81 SYNC mode output parameters

6.2.32.2 Cycle time

Displays the cycle time of the output parameters. In Sync Manager synchronous mode, the value is measured while in Distributed Clock synchronous mode, the value is taken from the SyncO cycle time register. The value is given in [ns].

Name	Cycle time
Index	0x1C32
Subindex	0x02
Data type	UNSIGNED32
Access type	RO
Default value	–
Value range	–
PDO mapping	NO
Backup	NO

6.2.32.3 Synchronization types supported

Displays the supported synchronization modes of the output parameters.

Name	Synchronization types supported	
Index	0x1C32	
Subindex	0x04	
Data type	UNSIGNED16	
Access type	RO	
Default value	0x0406 (→ Table 6-82)	
Value range	–	–
PDO mapping	NO	
Backup	NO	

Bit	Description
15...12	reserved
11	Fixed delay time (synchronization executed by hardware)
10...7	reserved
6, 5	Shift settings 00 = No output shift supported
4...2	DC mode supported 000 = No DC 001 = DC Sync0
1	Synchronous supported
0	FreeRun supported

Table 6-82 Synchronization types supported – Output parameters

6.2.32.4 Minimum cycle time

Displays the minimum cycle time of the output parameters. The value is given in [ns].

Name	Minimum cycle time	
Index	0x1C32	
Subindex	0x05	
Data type	UNSIGNED32	
Access type	RO	
Default value	1'000'000	
Value range	–	–
PDO mapping	NO	
Backup	NO	

6.2.32.5 Calc and copy time

The time needed by the application controller to copy the process data from the Sync Manager to the local memory and to perform calculations, if necessary, before the data is sent to the process. The value is given in [ns].

Name	Calc and copy time	
Index	0x1C32	
Subindex	0x06	
Data type	UNSIGNED32	
Access type	RO	
Default value	1'000	
Value range	–	–
PDO mapping	NO	
Backup	NO	

6.2.32.6 Delay time

The hardware delay time of the slave. The time from receiving the trigger (Sync0 or Sync1 Event) to drive output values to the time until they become valid in the process. The value is given in [ns].

Name	Delay time	
Index	0x1C32	
Subindex	0x09	
Data type	UNSIGNED32	
Access type	RO	
Default value	1'000	
Value range	–	–
PDO mapping	NO	
Backup	NO	

6.2.32.7 Cycle time too small

The cycle time too small/even counter.

Name	Cycle time too small	
Index	0x1C32	
Subindex	0x0C	
Data type	UNSIGNED16	
Access type	RO	
Default value	0	
Value range	–	–
PDO mapping	NO	
Backup	NO	

6.2.33 SYNC manager 3 parameter



The object is only available if the active fieldbus is EtherCAT.

Used to display the synchronization of the input parameters.

Name	SYNC manager 3 parameter
Index	0x1C33
Object code	RECORD
Highest subindex supported	12

6.2.33.1 Synchronization type

Displays the synchronization type of the input parameters.

Name	Synchronization type
Index	0x1C33
Subindex	0x01
Data type	UNSIGNED16
Access type	RO
Default value	Synchronous with SM2
Value range	→ Table 6-83
PDO mapping	NO
Backup	NO

Value	Description
0x0002	Distributed clock Sync0: Synchronous with SYNC0 event
0x0022	Synchronous with SM2: Synchronous with SM2 event

Table 6-83 SYNC mode input parameters

6.2.33.2 Cycle time

Displays the cycle time of the input parameters. In Sync Manager synchronous mode, the value is measured while in Distributed Clock synchronous mode, the value is taken from the SyncO cycle time register. The value is given in [ns].

Name	Cycle time
Index	0x1C33
Subindex	0x02
Data type	UNSIGNED32
Access type	RO
Default value	–
Value range	–
PDO mapping	NO
Backup	NO

6.2.33.3 Synchronization types supported

Displays the supported synchronization modes of the input parameters.

Name	Synchronization types supported	
Index	0x1C33	
Subindex	0x04	
Data type	UNSIGNED16	
Access type	RO	
Default value	0x0406 (→ Table 6-84)	
Value range	–	–
PDO mapping	NO	
Backup	NO	

Bit	Description
15...7	reserved
6, 5	Shift settings 00 = No output shift supported
4...2	DC mode supported 000 = No DC 001 = DC Sync0
1	Synchronous supported
0	FreeRun supported

Table 6-84 Synchronization types supported – Input parameters

6.2.33.4 Minimum cycle time

Displays the minimum cycle time of the input parameters. The value is given in [ns].

Name	Minimum cycle time	
Index	0x1C33	
Subindex	0x05	
Data type	UNSIGNED32	
Access type	RO	
Default value	1'000'000	
Value range	–	–
PDO mapping	NO	
Backup	NO	

6.2.33.5 Calc and copy time

The time needed by the application controller to copy the process data from the Sync Manager to the local memory and to perform calculations, if necessary, before the data is sent to the process. The value is given in [ns].

Name	Calc and copy time	
Index	0x1C33	
Subindex	0x06	
Data type	UNSIGNED32	
Access type	RO	
Default value	1'000	
Value range	–	–
PDO mapping	NO	
Backup	NO	

6.2.33.6 Cycle time too small

The cycle time too small/even counter. For details.

Name	Cycle time too small	
Index	0x1C33	
Subindex	0x0C	
Data type	UNSIGNED16	
Access type	RO	
Default value	0	
Value range	–	–
PDO mapping	NO	
Backup	NO	

6.2.34 Program data

Used to download a firmware file (msdc). Download will commence only if both, a stop program command and a clear program command were immediately received by →Program control.

Related objects: →“Program control” on page 6-119

Name	Program data
Index	0x1F50
Object code	ARRAY
Highest subindex supported	1

6.2.34.1 Program number 1

Name	Program number 1	
Index	0x1F50	
Subindex	0x01	
Data type	DOMAIN	
Access type	WO	
Default value	-	
Value range	-	-
PDO mapping	NO	
Backup	NO	

6.2.35 Program control

Initiates firmware download related commands and reads back information on the running application.

While the bootloader is active, only a subset of objects is supported and only one communication interface can be used. For example: The bootloader is activated with the stop program command. If the first command received by the bootloader is sent by USB, the communication is possible via USB only until the application is started with a start program command or a device reset is performed.

To successfully perform a firmware update, the following command sequence must be executed:

Stop program – clear program – download program with write access to →Program data

Related objects: →“Program data” on page 6-118

Name	Program control
Index	0x1F51
Object code	ARRAY
Highest subindex supported	1

6.2.35.1 Program number 1

Name	Program number 1
Index	0x1F51
Subindex	0x01
Data type	UNSIGNED8
Access type	RW
Default value	–
Value range	→Table 6-85
PDO mapping	NO
Backup	NO

Value	Write access	Read access
0x00	Stop program: Activate bootloader application	Program stopped: Bootloader application is active
0x01	Start program: Activate Program	Program started: Program is active
0x02	Reset program: Initiate device reset	Not used
0x03	Clear program: Erase the flash memory before new program data is downloaded	No program available: No valid application is available in the flash memory
0x04...0x07	reserved	reserved
0x80	Triggers an ESM state change acknowledge upon application restart. Relevant only for EPOS4 bootloader OBD.	–

Table 6-85 Program control – Value range

6.2.36 Program software identification

Provides identification on the loaded program software.

If no valid flash content or program software is available, the program software identification is “0” (zero).

While the bootloader is active, the identification of the actually running bootloader version is returned. After a bootloader update, a device reset or start program command is required for display of the new identification number.

Name	Program software identification
Index	0x1F56
Object code	ARRAY
Highest subindex supported	1

6.2.36.1 Program number 1

Name	Program number 1
Index	0x1F56
Subindex	0x01
Data type	UNSIGNED32
Access type	RO
Default value	–
Value range	→Table 6-86
PDO mapping	NO
Backup	NO

Bit	Description
31...16	Identification of the application
15...0	Identification of the bootloader

Table 6-86 Program software identification – Value range

6.2.37 Flash status identification

Displays the status of the firmware download process.

Name	Flash status identification
Index	0x1F57
Object code	ARRAY
Highest subindex supported	1

6.2.37.1 Program number 1

Name	Program number 1
Index	0x1F57
Subindex	0x01
Data type	UNSIGNED32
Access type	RO
Default value	–
Value range	→Table 6-87
PDO mapping	NO
Backup	NO

Continued on next page.

Bit	Value	Description	
31...16		Manufacturer-specific information	
15...8		Reserved, always 0	
7...1	127...93	Reserved for manufacturer-specific errors	
	92	Decryption error (a)	
	91	Authentication sequence error. Expected command sequence (activate bootloader – clear program – write program data) was not observed. (a)	
	90	Flash clear error (a)	
	89	Hardware version mismatch. Received firmware cannot be use with this hardware; manufacturer-specific error. (a)	
	88	Unspecified error (a)	
	87	Flash secured. Write access currently forbidden. (a)	
	86	General address error (a)	
	85	Flash write error (a)	
	84	Flash not cleared before write (a)	
	83	Data format error or data CRC error (a)	
	82	Data format unknown (a)	
	81	No valid program available (a)	
	80...68	Reserved for manufacturer-specific errors (a)	
	67	Decryption error	
	66	Authentication sequence error: Expected command sequence (activate bootloader – clear program – write program data) was not observed.	
	65	Flash clear error	
	64	Hardware version mismatch. Received firmware cannot be use with this hardware; manufacturer-specific error.	
	63	Unspecified error	
	62...8	Reserved	
	7	Flash secured. Write access currently forbidden.	
	6	General address error	
	5	Flash write error	
	4	Flash not cleared before write	
	3	Data format error or data CRC error	
	2	Data format unknown	
	1	No valid program available	
	0	No error occurred, valid program available	
	0	1	Download in progress. Program Software Identification is not valid.
		0	No download in progress. Program Software Identification is valid.

(a) Error received from extension communication module

Table 6-87 Flash status identification – Value range

6.2.38 Node-ID

Defines the node ID of the device and is used by the communication interfaces CAN, USB, and RS232.

If the hardware DIP switches are not set to "0" (zero), the node ID is defined by the DIP switches. The value is read at boot-up and is visible in this object. If the DIP switches are set to "0" (zero), the node ID can be defined by this object. For detailed information on DIP switches → separate document «Hardware Reference» of respective controller.

Changes to this object only come into effect after restart. Therefore, storing all parameters after a change is required, then restart.

Name	Node-ID	
Index	0x2000	
Subindex	0x00	
Data type	UNSIGNED8	
Access type	RW	
Default value	1	
Value range	1	127
PDO mapping	NO	
Backup	YES	

6.2.39 CAN bit rate



The object is only available if the active fieldbus is CANopen.

Holds the desired bit rate of the CAN interface.

Changes to this object only come into effect after restart. Therefore, storing all parameters after a change is required, then restart.

Automatic bit rate detection is activated in the following cases:

- CAN bit rate is set to “9” and saved (followed by reset/power on).
- Hardware DIP switch pin “CAN automatic bit rate detection” is activated (during reset/power on).

Name	CAN bit rate
Index	0x2001
Subindex	0x00
Data type	UNSIGNED8
Access type	RW
Default value	0
Value range	→Table 6-88
PDO mapping	NO
Backup	YES

Value	Bit rate
0	1 Mbit/s
1	800 kbit/s
2	500 kbit/s
3	250 kbit/s
4	125 kbit/s
(5)	<i>reserved</i>
6	50 kbit/s
7	20 kbit/s
(8)	<i>not supported (10 kbit/s)</i>
9	Automatic bite rate detection

Table 6-88 CAN bit rate

6.2.40 RS232 bit rate

Sets the bit rate of the serial communication interface.

Changes to this object only come into effect after restart. Therefore, storing all parameters after a change is required, then restart.

Name	RS232 bit rate
Index	0x2002
Subindex	0x00
Data type	UNSIGNED8
Access type	RW
Default value	5
Value range	→Table 6-89
PDO mapping	NO
Backup	YES

Value	Bit rate
0	9.6 kbit/s
1	14.4 kbit/s
2	19.2 kbit/s
3	38.4 kbit/s
4	57.6 kbit/s
5	115.2 kbit/s

Table 6-89 RS232 bit rate

6.2.41 RS232 frame timeout

Defines the timeout over a RS232 communication frame. It is scaled in [ms].

Name	RS232 frame timeout	
Index	0x2005	
Subindex	0x00	
Data type	UNSIGNED16	
Access type	RW	
Default value	500	
Value range	50	65'535
PDO mapping	NO	
Backup	YES	

6.2.42 USB frame timeout

Defines the timeout over a USB communication frame. It is scaled in [ms].

Name	USB frame timeout	
Index	0x2006	
Subindex	0x00	
Data type	UNSIGNED16	
Access type	RW	
Default value	500	
Value range	50	65'535
PDO mapping	NO	
Backup	YES	

6.2.43 CAN bit rate display

The object is only available if the active fieldbus is CANopen.

Represents the actually configured CAN bit rate. Its value can differ from the value of the object →“CAN bit rate” on page 6-124 if automatic bit rate detection is or was active. In all other cases, the value of these two objects are identical.

Related objects: →“CAN bit rate” on page 6-124

Name	CAN bit rate display	
Index	0x200A	
Subindex	0x00	
Data type	UNSIGNED8	
Access type	RO	
Default value	–	
Value range	→Table 6-88	
PDO mapping	NO	
Backup	NO	

6.2.44 Active fieldbus

Shows the actual active fieldbus.

Name	Active fieldbus
Index	0x2010
Subindex	0x00
Data type	UNSIGNED8
Access type	RO
Default value	–
Value range	→Table 6-90
PDO mapping	NO
Backup	NO

Value	Fieldbus
0	None
1	CANopen
2	EtherCAT

Table 6-90 Fieldbus type

6.2.45 Additional identity

Name	Additional identity
Index	0x2100
Object code	RECORD
Highest subindex supported	1

6.2.45.1 Serial number complete

Contains the full 64-bit device serial number.

Name	Serial number complete
Index	0x2100
Subindex	0x01
Data type	UNSIGNED64
Access type	RO
Default value	–
Value range	–
PDO mapping	NO
Backup	YES

6.2.46 Extension 1 identity

Shows version information of the connected extension communication.

Name	Extension 1 identity
Index	0x2101
Object code	RECORD
Highest subindex supported	6

6.2.46.1 Extension 1 software version

Contains the software version of the connected extension communication.

Name	Extension 1 software version	
Index	0x2101	
Subindex	0x01	
Data type	UNSIGNED16	
Access type	RO	
Default value	–	
Value range	–	–
PDO mapping	NO	
Backup	NO	

6.2.46.2 Extension 1 hardware version

Contains the software version of the connected extension communication.

Name	Extension 1 hardware version	
Index	0x2101	
Subindex	0x02	
Data type	UNSIGNED16	
Access type	RO	
Default value	–	
Value range	→Table 6-91	
PDO mapping	NO	
Backup	NO	

Hardware version	Hardware
0x5100	EtherCAT extension (card or connector board)

Table 6-91 Extension 1 hardware – Version definition

6.2.46.3 Extension 1 application number

Contains the application number of the connected extension communication.

Name	Extension 1 application number	
Index	0x2101	
Subindex	0x03	
Data type	UNSIGNED16	
Access type	RO	
Default value	–	
Value range	–	–
PDO mapping	NO	
Backup	NO	

6.2.46.4 Extension 1 application version

Contains the application number of the connected extension communication.

Name	Extension 1 application version	
Index	0x2101	
Subindex	0x04	
Data type	UNSIGNED16	
Access type	RO	
Default value	–	
Value range	–	–
PDO mapping	NO	
Backup	NO	

6.2.46.5 Extension 1 serial number

Contains the full 64-bit device serial number of the connected extension communication.

Name	Extension 1 serial number	
Index	0x2101	
Subindex	0x05	
Data type	UNSIGNED64	
Access type	RO	
Default value	–	
Value range	–	–
PDO mapping	NO	
Backup	NO	

6.2.46.6 Extension 1 type

Contains the type of the connected extension communication.

Name	Extension 1 type
Index	0x2101
Subindex	0x06
Data type	UNSIGNED64
Access type	RO
Default value	–
Value range	→Table 6-92
PDO mapping	NO
Backup	NO

Value	Fieldbus
0	None
2	EtherCAT

Table 6-92 Extension communication type

6.2.47 Custom persistent memory

Name	Custom persistent memory
Index	0x210C
Object code	ARRAY
Highest subindex supported	4

6.2.47.1 Custom persistent memory (1...4)

Can be used to store custom values (for example axis numbers, identifications, etc.) on the EPOS4. The stored values will not be evaluated by the firmware but will be cleared by setting the default parameters.

Names	Custom persistent memory 1 Custom persistent memory 2 Custom persistent memory 3 Custom persistent memory 4
Index	0x210C
Subindex	0x01...0x04
Data type	UNSIGNED32
Access type	RW
Default value	0
Value range	–
PDO mapping	NO
Backup	YES

6.2.48 Power supply

Used to display the power supply parameters.

Name	Power supply
Index	0x2200
Object code	RECORD
Highest subindex supported	1

6.2.48.1 Power supply voltage

Represents the actual power supply voltage. The value is given in [0.1 V].

Name	Power supply voltage	
Index	0x2200	
Subindex	0x01	
Data type	UNSIGNED16	
Access type	RO	
Default value	-	
Value range	-	-
PDO mapping	NO	
Backup	NO	

6.2.49 Axis configuration

Used to setup the main components of the axis by configuring the sensors and the control structure.

Write access is only permitted in device state «Power Disable».

Related objects: →“Motor type” on page 6-227

Name	Axis configuration
Index	0x3000
Object code	ARRAY
Highest subindex supported	6

6.2.49.1 Sensors configuration

Used to define the sensor types used for the axis.

- If →“Motor type” on page 6-227 is set to “brushed DC motor”, the field “Digital Hall sensor” is set to “none”.
- Upon changing this parameter, the absolute position may be corrupted. Therefore, «Position referenced to home position» (→“Statusword” on page 6-200), →“Position actual value” on page 6-204, and →“Additional position actual values” on page 6-221 will be cleared.

Related objects: →“Digital incremental encoder 1” on page 6-151 / →“Digital incremental encoder 2” on page 6-162 / →“Digital Hall sensor” on page 6-161 / →“SSI absolute encoder” on page 6-155 / →“Analog incremental encoder” on page 6-153

Name	Sensors configuration
Index	0x3000
Subindex	0x01
Data type	UNSIGNED32
Access type	RW
Default value	0x00100001
Value range	→Table 6-93 and Table 6-94
PDO mapping	NO
Backup	YES

Bit 31...24	Bit 23...16	Bit 15...8	Bit 7...0
reserved (0)	Sensor 3 type	Sensor 2 type	Sensor 1 type

Table 6-93 Sensor configuration – Bits

Continued on next page.

Name	Value	Description
Sensor 1 type	0x00	None
	0x01	Digital incremental encoder 1
Sensor 2 type	0x00	None
	0x01	Digital incremental encoder 2
	0x02	Analog incremental encoder
	0x03	SSI absolute encoder
Sensor 3 type	0x00	None
	0x10	Digital Hall Sensor (EC motors only)

Table 6-94 Supported sensor types



For detailed information on socket and pin assignment → separate document «Hardware Reference» of respective controller.

6.2.49.2 Control structure

Defines the control structure of the axis depended on the available sensors.

- The main sensor and the auxiliary sensor can only be selected if the corresponding value of →Sensors configuration (0x3000; 0x01) has been configured (not “none”).
- The auxiliary sensor can only be selected if the main sensor has been configured (not “none”).
- The auxiliary sensor must be mounted on the motor shaft.
- Using one single physical sensor for the purpose of both main sensor and auxiliary sensor is not permitted.
- Setting the mounting position of a sensor on a gear is only permitted if a gear has been configured (not “none”).
- The mounting positions of the auxiliary sensor and the main sensor cannot be the same. If this behavior is required, the gear ratio must be set to 1:1 (virtual gear).
- The mounting position for commutation sensors must be “on motor”.
- Dual loop position controller can only be selected if both main sensor and auxiliary sensor have been configured (not “none”). Single loop controller is supported with main sensor only.
- The process value reference must be of the same value as the mounting position of the sensor that is configured as main sensor. If sensor 1 is mounted “on gear” and configured as main sensor, the process value reference must be “on gear” as well.
- Take into account that the position control quality depends, among other influences, on the resolution of the main sensor. For some sensor types, such as SSI, the “position refresh rate” has an additional influence on the position control quality. Increase the sensor’s “data rate” to improve position control quality.
- Upon changing this parameter, the absolute position may be corrupted. Therefore, →«Position referenced to home position» (→“Statusword” on page 6-200), →“Position actual value” on page 6-204, and →“Additional position actual values” on page 6-221 will be cleared.

Name	Control structure
Index	0x3000
Subindex	0x02
Data type	UNSIGNED32
Access type	RW
Default value	0x00010111
Value range	→Table 6-95, Table 6-96, and Table 6-97
PDO mapping	NO
Backup	YES

Continued on next page.

Bit	Name	Value	Description
31...30	reserved	0	–
29...28	Mounting Position Sensor 3	0	On motor
27...26	Mounting Position Sensor 2	0	On motor (or undefined)
		1	On gear
25...24	Mounting Position Sensor 1	0	On motor (or undefined)
		1	On gear
23...20	Auxiliary Sensor	0	None
		1	Sensor 1
		2	Sensor 2
		3	Sensor 3
19...16	Main Sensor	0	None
		1	Sensor 1
		2	Sensor 2
		3	Sensor 3
15...14	Process Value Reference	0	On motor (or undefined)
		1	On gear
13	reserved	0	–
12	Gear	0	None
		1	Gear mounted to the system
11...8	Position Control Structure	0	None
		1	PID position controller
		2	Dual loop position controller
7...4	Velocity Control Structure	0	None
		1	PI velocity controller (low pass filter)
		2	PI velocity controller (observer)
3...0	Current Control Structure	1	PI current controller

Table 6-95 Control structure – Bits

Continued on next page.

CONFIGURATION WITHOUT GEAR

Value (hex)	Description	DC	EC block	EC sinus
0 x 0 0 0 0 0 0 0 1 	*1) *3) PI current controller No PI velocity controller No PID position controller Process value reference on motor (or undefined) No main sensor Mounting position on motor (or undefined)	✓	✓	✓
0 x 0 0 0 1 0 1 V 1 	PI current controller PI velocity controller with [1: low pass filter, 2: observer] PID position controller Process value reference on motor (or undefined) Sensor 1 is main sensor Mounting position on motor (or undefined)	✓	✓	✓
0 x 0 0 0 2 0 1 V 1 	PI current controller PI velocity controller with [1: low pass filter, 2: observer] PID position controller Process value reference on motor (or undefined) Sensor 2 is main sensor Mounting position on motor (or undefined)	✓	✓	✓
0 x 0 0 0 3 0 1 V 1 *2) 	PI current controller PI velocity controller with [1: low pass filter, 2: observer] PID position controller Process value reference on motor (or undefined) Sensor 3 is main sensor Mounting position on motor (or undefined)	—	✓	✓

- (*1) Configuration does not support max speed limitation
- (*2) Configuration reduces control quality due to poor sensor resolution
- (*3) Configuration supports CST mode only

Table 6-96 Control structure without gear – permitted values

Continued on next page.

CONFIGURATION WITH GEAR

Value (hex)	Description	Motor		
		DC	EC block	EC sinus
0 x 0 M 0 0 1 0 0 1	<p>*1) *3) *4)</p> <ul style="list-style-type: none"> PI current controller No PI velocity controller No PID position controller Gear configured process value reference on motor (or undefined) No main sensor Mounting position sensor 1 on motor sensor 2 [0: on motor, 4: on gear] Mounting position sensor 3 on motor (or undefined) 	✓	✓	✓
0 x 0 M 0 0 1 0 0 1	<p>*1) *3) *4)</p> <ul style="list-style-type: none"> PI current controller No PI velocity controller No PID position controller Gear configured process value reference on motor (or undefined) No main sensor Mounting position sensor 1 on gear sensor 2 [1: on motor, 5: on gear] Mounting position sensor 3 on motor (or undefined) 	✓	✓	✓
0 x 0 M 0 1 1 1 V 1	<ul style="list-style-type: none"> PI current controller PI velocity controller with [1: low pass filter, 2: observer] PID position controller Gear configured process value reference on motor (or undefined) Sensor 1 is main sensor Mounting position sensor 1 on motor sensor 2 [0: on motor, 4: on gear] Mounting position sensor 3 on motor (or undefined) 	✓	✓	✓
0 x 0 M 0 2 1 1 V 1	<ul style="list-style-type: none"> PI current controller PI velocity controller with [1: low pass filter, 2: observer] PID position controller Gear configured process value reference on motor (or undefined) Sensor 2 is main sensor Mounting position sensor 1 [0: on motor, 1: on gear] sensor 2 on motor Mounting position sensor 3 on motor (or undefined) 	✓	✓	✓
0 x 0 1 0 1 5 1 V 1	<ul style="list-style-type: none"> PI current controller PI velocity controller with [1: low pass filter, 2: observer] PID position controller Gear configured process value reference on gear Sensor 1 is main sensor Mounting position sensor 1 on gear sensor 2 on motor Mounting position sensor 3 on motor (or undefined) 	✓	✓	✓

Continued on next page.

Value (hex)	Description	Motor		
		DC	EC block	EC sinus
0 x 0 5 0 1 5 1 V 1	<ul style="list-style-type: none"> PI current controller PI velocity controller with [1: low pass filter, 2: observer] PID position controller Gear configured process value reference on gear Sensor 1 is main sensor Mounting position sensor 1 on gear sensor 2 on gear Mounting position sensor 3 on motor (or undefined) 	✓	✓	—
0 x 0 4 0 2 5 1 V 1	<ul style="list-style-type: none"> PI current controller PI velocity controller with [1: low pass filter, 2: observer] PID position controller Gear configured process value reference on gear Sensor 2 is main sensor Mounting position sensor 1 on motor sensor 2 on gear Mounting position sensor 3 on motor (or undefined) 	✓	✓	✓
0 x 0 5 0 2 5 1 V 1	<ul style="list-style-type: none"> PI current controller PI velocity controller with [1: low pass filter, 2: observer] PID position controller Gear configured process value reference on gear Sensor 2 is main sensor Mounting position sensor 1 on gear sensor 2 on gear Mounting position sensor 3 on motor (or undefined) 	✓	✓	—
0 x 0 M 0 3 1 1 V 1 *2)	<ul style="list-style-type: none"> PI current controller PI velocity controller with [1: low pass filter, 2: observer] PID position controller Gear configured process value reference on motor (or undefined) Sensor 3 is main sensor Mounting position sensor 1 on motor sensor 2 [0: on motor, 4: on gear] Mounting position sensor 3 on motor (or undefined) 	—	✓	✓
0 x 0 1 0 3 1 1 V 1 *2)	<ul style="list-style-type: none"> PI current controller PI velocity controller with [1: low pass filter, 2: observer] PID position controller Gear configured process value reference on motor (or undefined) Sensor 3 is main sensor Mounting position sensor 1 on gear sensor 2 on motor Mounting position sensor 3 on motor (or undefined) 	—	✓	✓

Continued on next page.

Value (hex)	Description	Motor		
		DC	EC block	EC sinus
0 x 0 5 0 3 1 1 V 1 *2) 	<ul style="list-style-type: none"> PI current controller PI velocity controller with [1: low pass filter, 2: observer] PID position controller Gear configured process value reference on motor (or undefined) Sensor 3 is main sensor Mounting position sensor 1 on gear sensor 2 on gear Mounting position sensor 3 on motor (or undefined) 	—	✓	—

- (*1) Configuration does not support max speed limitation
- (*2) Configuration reduces control quality due to poor sensor resolution
- (*3) Configuration supports CST mode only
- (*4) Gear configuration has no effect on system behavior

Table 6-97 Control structure with gear – permitted values

Continued on next page.

CONFIGURATION WITH GEAR AND DUAL LOOP CONTROL

Value (hex)	Description	DC	Motor		
			EC	block EC	sinus
0 x 0 1 2 1 5 2 V 1 	<ul style="list-style-type: none"> PI current controller PI velocity controller with [1: low pass filter, 2: observer] Dual loop position control Gear configured process value reference on gear Sensor 1 is main sensor Sensor 2 is auxiliary sensor Mounting position sensor 1 on gear sensor 2 on motor Mounting position sensor 3 on motor (or undefined) 	✓	✓	✓	
0 x 0 1 3 1 5 2 V 1 *2) *5) 	<ul style="list-style-type: none"> PI current controller PI velocity controller with [1: low pass filter, 2: observer] Dual loop position control Gear configured process value reference on gear Sensor 1 is main sensor Sensor 3 is auxiliary sensor Mounting position sensor 1 on gear sensor 2 on motor (or undefined) Mounting position sensor 3 on motor (or undefined) 	—	✓	✓	
0 x 0 5 3 1 5 2 V 1 *2) 	<ul style="list-style-type: none"> PI current controller PI velocity controller with [1: low pass filter, 2: observer] Dual loop position control Gear configured process value reference on gear Sensor 1 is main sensor Sensor 3 is auxiliary sensor Mounting position sensor 1 on gear sensor 2 on gear Mounting position sensor 3 on motor (or undefined) 	—	✓	—	
0 x 0 4 1 2 5 2 V 1 	<ul style="list-style-type: none"> PI current controller PI velocity controller with [1: low pass filter, 2: observer] Dual loop position control Gear configured process value reference on gear Sensor 2 is main sensor Sensor 1 is auxiliary sensor Mounting position sensor 2 on gear sensor 1 on motor Mounting position sensor 3 on motor (or undefined) 	✓	✓	✓	

Continued on next page.

Value (hex)	Description	DC	Motor	
			EC block	EC sinus
0 x 0 4 3 2 5 2 V 1 	(*2) (*5) PI current controller PI velocity controller with [1: low pass filter, 2: observer] Dual loop position control Gear configured process value reference on gear Sensor 2 is main sensor Sensor 3 is auxiliary sensor Mounting position sensor 2 on gear sensor 1 on motor (or undefined) Mounting position sensor 3 on motor (or undefined)	—	✓	✓
0 x 0 5 3 2 5 2 V 1 	(*2) PI current controller PI velocity controller with [1: low pass filter, 2: observer] Dual loop position control Gear configured process value reference on gear Sensor 2 is main sensor Sensor 3 is auxiliary sensor Mounting position sensor 1 on gear sensor 2 on gear Mounting position sensor 3 on motor (or undefined)	—	✓	—

(*2) Configuration reduces control quality due to poor sensor resolution

(*5) Depending on mounting position of auxiliary sensor, sinusoidal commutation may not be possible

Table 6-98 Control structure without gear and dual loop control – permitted values

6.2.49.3 Commutation sensors

Defines the control structure of the axis dependent on the available sensors and their disposition.

Defines the commutation sensors for the axis motor. For “brushed DC motor” without meaning. For “brushless DC motor”, the entry may not be set to 0x0000 (no commutation sensor defined). “Sensor absolute” is used for sensors that do not require additional alignment to perform commutation (for example digital Hall sensors). In contrast, “Sensor relative” is used if additional algorithms are required to use the sensor as commutation sensor (for example digital incremental encoder). Combinations of both relative and absolute commutation sensor are possible.

- The commutation sensor absolute, as well as the commutation sensor relative can only be selected if the corresponding value of «Sensor configuration» is configured (not none).
- If a sensor is used as commutation sensor, it must be mounted on the motor shaft. The configuration is done by →“Control structure” on page 6-134.
- For some sensor types, such as SSI, the position refresh rate has an influence on the commutation quality. Increase the sensor’s “data rate” to improve commutation quality or do not use relating sensor for commutation.

Name	Commutation sensors
Index	0x3000
Subindex	0x03
Data type	UNSIGNED32
Access type	RW
Default value	0x00000031
Value range	→Table 6-99 and Table 6-100
PDO mapping	NO
Backup	YES

Bit	Name	Value	Description
31...8	reserved	0	–
7...4	Commutation Sensor Absolute	0	None
		2	Sensor 2
		3	Sensor 3
3...0	Commutation Sensor Relative	0	None
		1	Sensor 1
		2	Sensor 2
		3	Sensor 3

Table 6-99 Commutation sensors – Bits

Value	Description	Motor type supported
0x00000000	No commutation sensor defined	DC motor
0x00000020	Sensor 2 used for commutation	EC sinus (SSI encoder only)
0x00000030	Sensor 3 used for commutation	EC block
0x00000031	Sensor 3 and Sensor 1 used for commutation	EC sinus
0x00000032	Sensor 3 and Sensor 2 used for commutation	EC sinus

Table 6-100 Commutation sensors – Value range

6.2.49.4 Axis configuration miscellaneous

Used to define various options regarding the axis configuration.

Name	Axis configuration miscellaneous
Index	0x3000
Subindex	0x04
Data type	UNSIGNED32
Access type	RW
Default value	0x00000000
Value range	→Table 6-101
PDO mapping	NO
Backup	YES

Bit	Name	Value	Description
31...10	reserved	0	–
9	Commutation (auxiliary) sensor supervision *1)	1	Commutation (auxiliary) sensor supervision disabled
		0	Commutation (auxiliary) sensor supervision enabled
8	Sensor supervision	1	Main sensor supervision disabled
		0	Main sensor supervision enabled
7...1	reserved	0	–
0	Axis polarity	1	Inverse polarity – rotational direction of the axis is CW when positive demanded values are attached
		0	Normal polarity – rotational direction of the axis is CCW when positive demanded values are attached

(*1) With a unsupervised commutation sensor, communication errors cannot be detected and the motor might possibly behave incorrect.

Table 6-101 Axis configuration miscellaneous – Bits

6.2.49.5 Main sensor resolution

Displays the resolution of the main sensor given in [increments/revolution].

Name	Main sensor resolution
Index	0x3000
Subindex	0x05
Data type	UNSIGNED32
Access type	RO
Default value	–
Value range	–
PDO mapping	NO
Backup	NO

6.2.49.6 Max system speed

Displays the max system speed. The value is given in [velocity units] (→page 2-16).

Related objects: →“Motor type” on page 6-227 / →“Max profile velocity” on page 6-210 / →“Max motor speed” on page 6-210 / →“Target velocity” on page 6-227 / →“Max gear input speed” on page 6-150

Name	Max system speed	
Index	0x3000	
Subindex	0x06	
Data type	UNSIGNED32	
Access type	RO	
Default value	–	
Value range	1	→ Table 6-102 → Table 6-103
PDO mapping	NO	
Backup	NO	

Velocity limit		Max motor speed greater Max gear input speed	Max motor speed lower or equal Max gear input speed
Gear	no	Max motor speed	Max motor speed
	yes	$\frac{\text{Max gear input speed}}{\text{Absolute gear reduction}}$	$\frac{\text{Max motor speed}}{\text{Absolute gear reduction}}$

Table 6-102 Max system speed – Limits

Velocity units factor	Max system speed limited by velocity units	Limit
$10^0 / 10^{-1} / 10^{-2} / 10^{-3} / 10^{-4}$	No	—
10^{-5}	Yes	21474.83647
10^{-6}	Yes	2147.483647

Table 6-103 Max system speed – Speed limitations based on velocity units

6.2.50 Motor data

Used to configure the parameters of the motor.

Some parameters are used to limit the output current according to the I2t method. For detailed motor specifications →maxon motor catalog.

Related objects: →“Motor type” on page 6-227

Name	Motor data
Index	0x3001
Object code	RECORD
Highest subindex supported	5

6.2.50.1 Nominal current

Represents the nominal current of the motor [mA]. Continuous operation of the motor at this current level and at 25 °C ambient will cause the winding to ultimately reach the specified maximal winding temperature. This assumes no heat sinking. The value can be substantially increased if the motor mount is made of heat-dissipating materials.

Related objects: →“Motor rated torque” on page 6-206

Name	Nominal current
Index	0x3001
Subindex	0x01
Data type	UNSIGNED32
Access type	RW
Default value	→Table 6-104
Value range	→Table 6-104
PDO mapping	RXPDO
Backup	YES

Hardware	Default	Min	Max
EPOS4 Module 24/1.5 EPOS4 Compact 24/1.5 CAN EPOS4 Compact 24/1.5 EtherCAT	1'500	0	1'500
EPOS4 Module 50/5 EPOS4 Compact 50/5 CAN EPOS4 Compact 50/5 EtherCAT	5'000	0	5'000
EPOS4 Module 50/8 EPOS4 Compact 50/8 CAN EPOS4 Compact 50/8 EtherCAT	8'000	0	8'000
EPOS4 Module 50/15 EPOS4 Compact 50/15 CAN EPOS4 Compact 50/15 EtherCAT	15'000	0	15'000
EPOS4 50/5	5'000	0	5'000
EPOS4 70/15	15'000	0	15'000

Table 6-104 Nominal current

6.2.50.2 Output current limit

Represents the maximal permissible current of the motor [mA]. We recommend to set the value to double of →Nominal current.

Related objects: →“Thermal time constant winding” on page 6-147

Name	Output current limit
Index	0x3001
Subindex	0x02
Data type	UNSIGNED32
Access type	RW
Default value	→Table 6-105
Value range	→Table 6-105
PDO mapping	RXPDO
Backup	YES

Hardware	Default	Min	Max
EPOS4 Module 24/1.5 EPOS4 Compact 24/1.5 CAN EPOS4 Compact 24/1.5 EtherCAT	4'500	0	4'500
EPOS4 Module 50/5 EPOS4 Compact 50/5 CAN EPOS4 Compact 50/5 EtherCAT	15'000	0	15'000
EPOS4 Module 50/8 EPOS4 Compact 50/8 CAN EPOS4 Compact 50/8 EtherCAT	30'000	0	30'000
EPOS4 Module 50/15 EPOS4 Compact 50/15 CAN EPOS4 Compact 50/15 EtherCAT	30'000	0	30'000
EPOS4 50/5	15'000	0	15'000
EPOS4 70/15	30'000	0	30'000

Table 6-105 Output current limit

6.2.50.3 Number of pole pairs

Represents the number of magnetic pole pairs (number of poles divided by 2) of the rotor of a brushless DC motor (maxon EC motor/BLDC motor).

Write access is only permitted in device state «Power Disable».

Related objects: →“Max motor speed” on page 6-210

Name	Number of pole pairs	
Index	0x3001	
Subindex	0x03	
Data type	UNSIGNED8	
Access type	RW	
Default value	1	
Value range	1	255
PDO mapping	NO	
Backup	YES	

6.2.50.4 Thermal time constant winding

Represents the thermal time constant of motor winding. It is used to calculate the length of time the →“Output current limit” on page 6-146 (subindex 0x02) is permitted to be connected to the motor. The value is given in [0.1 s]. Example: For a time constant of 4 seconds, set the value “40”.

Name	Thermal time constant winding	
Index	0x3001	
Subindex	0x04	
Data type	UNSIGNED16	
Access type	RW	
Default value	40	
Value range	1	10'000
PDO mapping	NO	
Backup	YES	

6.2.50.5 Torque constant

Represents the motor's torque constant. The value is given in [$\mu\text{Nm/A}$].

Related objects: →“Motor rated torque” on page 6-206

Name	Torque constant	
Index	0x3001	
Subindex	0x05	
Data type	UNSIGNED32	
Access type	RW	
Default value	0	
Value range	0	10'000'000
PDO mapping	NO	
Backup	YES	

6.2.51 Electrical system parameters

The parameters are evaluated during the auto tuning identification of the electrical system. They are used during the auto tuning identification of the mechanical system to calculate the torque constant as well as for the sensor supervision.

Name	Electrical system parameters
Index	0x3002
Object code	RECORD
Highest subindex supported	2

6.2.51.1 Electrical resistance

Represents the electrical system resistance. The value is given in [mΩ].

Name	Electrical resistance	
Index	0x3002	
Subindex	0x01	
Data type	UNSIGNED32	
Access type	RW	
Default value	0	
Value range	0	4'294'967'295
PDO mapping	NO	
Backup	YES	

6.2.51.2 Electrical inductance

Represents the electrical system inductance. The value is given in [μH].

Name	Electrical inductance	
Index	0x3002	
Subindex	0x02	
Data type	UNSIGNED16	
Access type	RW	
Default value	0	
Value range	0	65'535
PDO mapping	NO	
Backup	YES	

6.2.52 Gear configuration

Used to setup configuration of a gear. A gear can only be used if the corresponding value of →Axis configuration (→Control structure) has been configured (not “none”).

Write access is only permitted in device state «Power Disable».

Related objects: →“Axis configuration” on page 6-132

Name	Gear configuration
Index	0x3003
Object code	RECORD
Highest subindex supported	4

6.2.52.1 Gear reduction numerator

The absolute gear reduction is calculated by division of gear reduction numerator by gear reduction denominator. It is also the ratio of input speed/turns as well as output speed/turns of a gear.

For detailed gear specifications →maxon motor catalog.

Name	Gear reduction numerator	
Index	0x3003	
Subindex	0x01	
Data type	UNSIGNED32	
Access type	RW	
Default value	1	
Value range	1	4'294'967'295
PDO mapping	NO	
Backup	YES	

6.2.52.2 Gear reduction denominator

The absolute gear reduction is calculated by division of gear reduction numerator by gear reduction denominator. It is also the ratio of input speed/turns as well as output speed/turns of a gear.

For detailed gear specifications →maxon motor catalog.

Name	Gear reduction denominator	
Index	0x3003	
Subindex	0x02	
Data type	UNSIGNED32	
Access type	RW	
Default value	1	
Value range	1	4'294'967'295
PDO mapping	NO	
Backup	YES	

6.2.52.3 Max gear input speed

Indicates the configured maximal allowed input speed for the gear. It serves as protection of the gear. Together with the →Max motor speed, it limits the gear's output speed. The value is given in [rpm].

For detailed gear specifications →maxon motor catalog.

Write access is permitted in device state «Power Enabled».

Related objects: →“Max profile velocity” on page 6-210 / →“Axis configuration” on page 6-132

Name	Max gear input speed	
Index	0x3003	
Subindex	0x03	
Data type	UNSIGNED32	
Access type	RW	
Default value	100'000	
Value range	1	100'000
PDO mapping	NO	
Backup	YES	

Velocity limit		Max motor speed greater Max gear input speed	Max motor speed lower or equal Max gear input speed
Gear	no	Max motor speed	Max motor speed
	yes	$\frac{\text{Max gear input speed}}{\text{Absolute gear reduction}}$	$\frac{\text{Max motor speed}}{\text{Absolute gear reduction}}$

Table 6-106 Gear velocity limits

6.2.52.4 Gear miscellaneous configuration

Used to define various options regarding the gear configuration.

Name	Gear miscellaneous configuration	
Index	0x3003	
Subindex	0x04	
Data type	UNSIGNED32	
Access type	RW	
Default value	0	
Value range	→Table 6-107	
PDO mapping	NO	
Backup	YES	

Bit	Name	Value	Description
31...1	reserved	0	–
0	Gear direction	0	Normal (rotational direction of input and output are the same)
		1	Inverted (rotational direction of input and output are opposite)

Table 6-107 Gear miscellaneous configuration – Bits

6.2.53 Digital incremental encoder 1

Defines the configuration of the digital incremental encoder 1.

Name	Digital incremental encoder 1
Index	0x3010
Object code	RECORD
Highest subindex supported	4

6.2.53.1 Digital incremental encoder 1 number of pulses

Defines the resolution of the digital incremental encoder 1. The value is given in [pulses/revolution]. Unit conversion is as follows:

$$4 \times \frac{\text{pulses}}{\text{revolutions}} = \frac{\text{increments}[\text{inc}]}{\text{revolutions}[\text{rev}]} = \frac{\text{quadcounts}[\text{qc}]}{\text{revolutions}[\text{rev}]}$$

Write access is only permitted in device state «Power Disable».

Name	Digital incremental encoder 1 number of pulses	
Index	0x3010	
Subindex	0x01	
Data type	UNSIGNED32	
Access type	RW	
Default value	500	
Value range	16	2'500'000
PDO mapping	NO	
Backup	YES	

6.2.53.2 Digital incremental encoder 1 type

Defines the configuration of the digital incremental encoder 1.

Write access is only permitted in device state «Power Disable».

Name	Digital incremental encoder 1 type
Index	0x3010
Subindex	0x02
Data type	UNSIGNED16
Access type	RW
Default value	0x0001
Value range	→Table 6-108
PDO mapping	NO
Backup	YES

Bit	Name	Value	Description
15...10	reserved	0	–
9	Method	0	Speed measured as time between two consecutive sensor edges
		1	Speed measured as number of sensor edges per control cycle
8...5	reserved	0	–
4	Direction	0	maxon
		1	Inverted (or encoder mounted on motor shaft)
3...1	reserved	0	–
0	Index	0	Encoder without index (2-channel)
		1	Encoder with index (3-channel)

Table 6-108 Digital incremental encoder 1 type – Bits

6.2.53.3 Digital incremental encoder 1 index position

Holds the digital incremental encoder 1 position reached upon last detected encoder index pulse. The value is given in [increments].

Name	Digital incremental encoder 1 index position	
Index	0x3010	
Subindex	0x04	
Data type	INTEGER32	
Access type	RO	
Default value	–	
Value range	–	–
PDO mapping	TXPDO	
Backup	NO	

6.2.54 Analog incremental encoder

Defines the configuration of the analog incremental encoder. Make sure to activate the encoder for the respective axis using →Axis configuration.

Write access is only permitted if the corresponding axis is in device state «Power Disable».

Related Objects: →“Axis configuration” on page 6-132

Name	Analog incremental encoder
Index	0x3011
Object code	RECORD
Highest subindex supported	3

6.2.54.1 Analog incremental encoder type

Defines the configuration of the analog incremental encoder.

Name	Analog incremental encoder type
Index	0x3011
Subindex	0x01
Data type	UNSIGNED16
Access type	RW
Default value	0x0001
Value range	→Table 6-109
PDO mapping	NO
Backup	YES

Bit	Name	Value	Description
15...5	reserved	0	–
4	Direction	0	maxon
		1	Inverted (or encoder mounted on motor shaft)
3...1	reserved	0	–
0	Index	0	Encoder without index (2-channel)
		1	Encoder with index (3-channel)

Table 6-109 Analog incremental encoder type – Bits

6.2.54.2 Analog incremental encoder resolution

Defines the resolution of the analog incremental encoder. Use “Number of periods” (bits 31...8) to set the analog incremental encoder’s number of periods per turn. Use “Interpolation bits” (bits 7...0) to define the desired interpolation within a period. Hence, the resolution yields as follows:

$$Resolution = 2^{InterpolationBits} \cdot PeriodsPerTurn \left[\frac{inc}{rev} \right]$$

Thereby, the following boundaries apply:

$$MaxResolution = 2^{InterpolationBits} \cdot PeriodsPerTurn \leq 10'000'000 \left[\frac{inc}{rev} \right]$$

$$MinResolution = 2^{InterpolationBits} \cdot PeriodsPerTurn \geq 64 \left[\frac{inc}{rev} \right]$$

Name	Analog incremental encoder resolution
Index	0x3011
Subindex	0x02
Data type	UNSIGNED32
Access type	RW
Default value	0x00080004
Value range	→Table 6-110
PDO mapping	NO
Backup	YES

Bit	Name	Min	Max	Default
31...8	Number of periods	1	2'500'000	2'048
7...0	Interpolation bits	2	10	4

Table 6-110 Analog incremental encoder resolution – Bits

6.2.54.3 Analog incremental encoder index position

Holds the analog incremental encoder’s position reached upon last detected encoder index pulse. The value is given in [inc].

Name	Analog incremental encoder index position		
Index	0x3011		
Subindex	0x03		
Data type	INTEGER32		
Access type	RO		
Default value	–		
Value range	–	–	–
PDO mapping	TXPDO		
Backup	NO		

6.2.55 SSI absolute encoder

Defines the configuration of the SSI absolute encoder. Make sure to activate the SSI absolute encoder for the respective axis using → “Axis configuration” on page 6-132.

Write access is only permitted if the corresponding axis is in state «Power Disable».

Name	SSI absolute encoder
Index	0x3012
Object code	RECORD
Highest subindex supported	10

6.2.55.1 SSI data rate

Represents the SSI encoder data rate (SSI clock frequency). The value is given in [kbit/s].

The maximal data rate depends on the actual cable length and the configuration of the encoder. For the correlation between cable length and data rate → Figure 6-41. Use cables with twisted pairs.

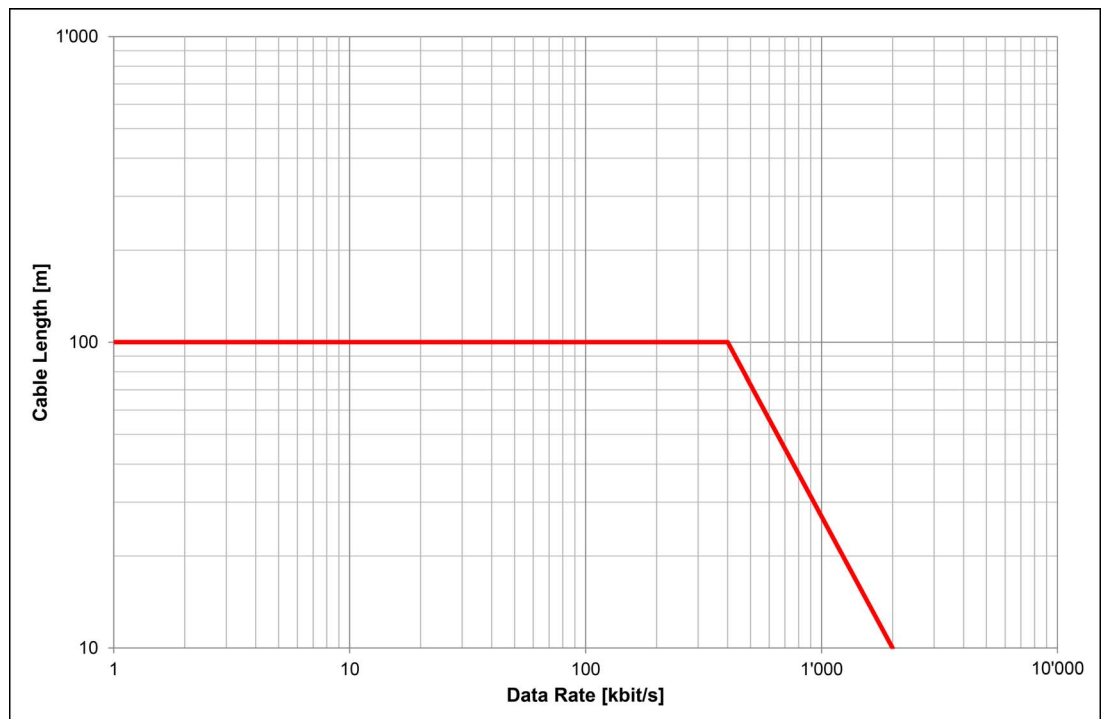

Figure 6-41 SSI encoder – Data rate vs. cable length

Name	SSI data rate	
Index	0x3012	
Subindex	0x01	
Data type	UNSIGNED16	
Access type	RW	
Default value	2'000	
Value range	400	2'000
PDO mapping	NO	
Backup	YES	

6.2.55.2 SSI number of data bits

Defines the number of multi-turn, single-turn, and special bits of the SSI data frame. The maximum value combined is 30 (including special bits → Figure 6-42). The resolution for rotary encoders is as follows:

$$Resolution = 2^{\text{Single-turn bits}} \left[\frac{inc}{rev} \right]$$

Name	SSI number of data bits
Index	0x3012
Subindex	0x02
Data type	UNSIGNED32
Access type	RW
Default value	0x00000C00
Value range	→ Table 6-111
PDO mapping	NO
Backup	YES

Bit	Name	Default	Min	Max
31...24	reserved	–	–	–
23...16	Multi-turn bits	0	0	24
15...8	Single-turn bits	12	6	23
7...0	Special bits	0	0	8

Table 6-111 SSI encoder – Number of data bits

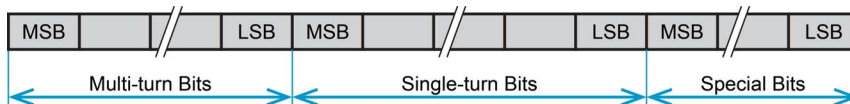

Figure 6-42 SSI encoder – Data frame

6.2.55.3 SSI encoding type

Defines the type of SSI encoding.

Name	SSI encoding type
Index	0x3012
Subindex	0x03
Data type	UNSIGNED16
Access type	RW
Default value	0x001
Value range	→Table 6-112
PDO mapping	NO
Backup	YES

Bit	Name	Value	Description	Default
15...5	reserved	0	–	0
4	Direction	0	maxon	0
		1	Inverted (or encoder mounted on motor shaft)	
3...0	Encoding type	0	Binary coded data	0
		1	Gray coded data	
		–	reserved	

Table 6-112 SSI encoder – Protocol

6.2.55.4 SSI timeout time

Represents the minimal duration after the last clock edge of a sequence until the first clock edge of the next sequence (→Figure 6-43). The value is given in [μs].

Name	SSI timeout time
Index	0x3012
Subindex	0x05
Data type	UNSIGNED16
Access type	RW
Default value	30
Value range	0 50
PDO mapping	NO
Backup	YES

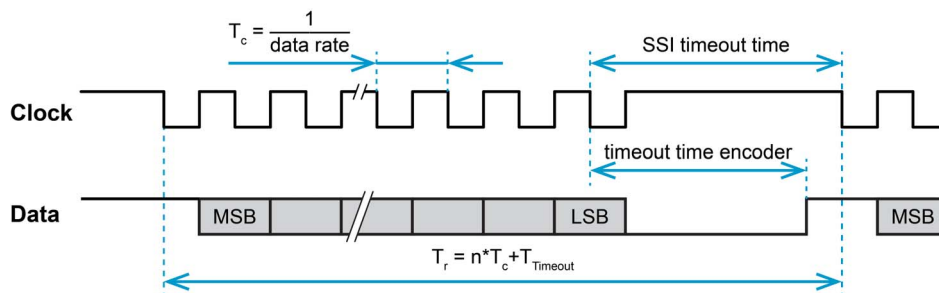

Figure 6-43 SSI encoder – Timing

6.2.55.5 SSI special bits data

The special bits of the SSI data frame will be copied to this object if the number of special bits >0 (→ Table 6-111). In EPOS4, no additional processing of the special bits will take place, thus, subsequent processing must be handled by the superior application.

Name	SSI special bits data	
Index	0x3012	
Subindex	0x06	
Data type	UNSIGNED16	
Access type	RO	
Default value	-	
Value range	-	-
PDO mapping	YES	
Backup	NO	

6.2.55.6 SSI refresh frequency

Displays the momentarily used refresh frequency. The maximal refresh frequency is 1/Tr. However, this can be smaller depending on the device's internal timings conditions (→ Figure 6-43). The value is given in [Hz]; typically are 25'000, 12'5000, 5'000.

Related objects: → "SSI absolute encoder" on page 6-155

Name	SSI refresh frequency	
Index	0x3012	
Subindex	0x07	
Data type	UNSIGNED32	
Access type	RO	
Default value	-	
Value range	-	-
PDO mapping	NO	
Backup	NO	

6.2.55.7 SSI power up time

Defines the duration from power-up until the SSI encoder is initialized and ready for operation. The value is given in [ms].

Name	SSI power up time	
Index	0x3012	
Subindex	0x08	
Data type	UNSIGNED16	
Access type	RW	
Default value	200	
Value range	0	10'000
PDO mapping	NO	
Backup	YES	

6.2.55.8 SSI position raw value

Represents the actual SSI absolute position raw value derived directly by the encoder.

Name	SSI position raw value	
Index	0x3012	
Subindex	0x09	
Data type	UNSIGNED32	
Access type	RO	
Default value	–	
Value range	–	–
PDO mapping	NO	
Backup	NO	

6.2.55.9 SSI commutation offset value

Represents the SSI absolute position offset value to align to the “0” (zero) angle position for commutation purposes. The SSI commutation offset [0...encoder resolution] represents [0°...360°].

For detailed information → separate document «EPOS4 Application Notes»; section “Adjustment of SSI Commutation Offset Value” (find a list of sources → chapter “1.1.6 Sources for additional Information” on page 1-9).

Name	SSI commutation offset value	
Index	0x3012	
Subindex	0x0A	
Data type	UNSIGNED32	
Access type	RW	
Default value	0	
Value range	–	–
PDO mapping	NO	
Backup	YES	

**Encoder alignment**

- If you are using a maxon absolute encoder, the alignment is factory-set and the “SSI commutation offset value” does not require to be set.
- If you are using a third party absolute encoder, you must...
 - either ensure that the alignment follows the specified pattern (→ Figure 6-44)
 - or use the “SSI commutation offset value” to align the angle position.

Continued on next page.

Signal Sequence of Hall Sensors

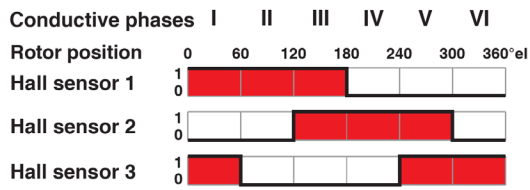

Supplied Motor Voltage (Phase to Phase)

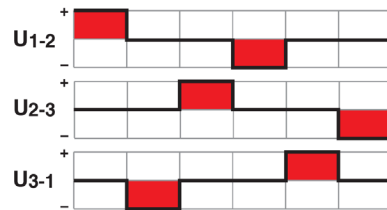

Figure 6-44 Block commutation of EC (BLDC) motors – Definition of phases

6.2.56 Digital Hall sensor

Defines the configuration of the digital Hall sensor. Make sure to activate the digital Hall sensor for the respective axis using →“Axis configuration” on page 6-132.

Name	Digital Hall sensor
Index	0x301A
Object code	ARRAY
Highest subindex supported	2

6.2.56.1 Digital Hall sensor type

Defines the configuration of the digital Hall sensor.

Write access is only permitted in device state «Power Disable».

Name	Digital Hall sensor type
Index	0x301A
Subindex	0x01
Data type	UNSIGNED16
Access type	RW
Default value	0
Value range	→Table 6-113
PDO mapping	NO
Backup	YES

Bit	Name	Value	Description
15...5	reserved	–	–
4	Method	0	Speed measured as time between two consecutive sensor edges
		1	Speed measured as number of sensor edges per control cycle
3...1	reserved	–	–
0	Polarity	0	maxon
		1	Inverted

Table 6-113 Digital Hall sensor – Bits

6.2.56.2 Digital Hall sensor pattern

Displays the actual state of the three digital Hall sensors as a pattern.

Name	Digital Hall sensor pattern	
Index	0x301A	
Subindex	0x02	
Data type	UNSIGNED16	
Access type	RO	
Default value	–	
Value range	–	–
PDO mapping	NO	
Backup	NO	

Bit	Hardware Signal
2	Digital Hall sensor 3
1	Digital Hall sensor 2
0	Digital Hall sensor 1

Table 6-114 Digital Hall sensor – Pattern

6.2.57 Digital incremental encoder 2

Defines the configuration of the digital incremental encoder 2.

Name	Digital incremental encoder 2
Index	0x3020
Object code	RECORD
Highest subindex supported	4

6.2.57.1 Digital incremental encoder 2 number of pulses

Defines the resolution of the digital incremental encoder 2. The value is given in [pulses/revolution]. Unit conversion is as follows:

$$4 \times \frac{\text{pulses}}{\text{revolutions}} = \frac{\text{increments}[\text{inc}]}{\text{revolutions}[\text{rev}]} = \frac{\text{quadcounts}[\text{qc}]}{\text{revolutions}[\text{rev}]}$$

Write access is only permitted in device state «Power Disable».

Name	Digital incremental encoder 2 number of pulses	
Index	0x3020	
Subindex	0x01	
Data type	UNSIGNED32	
Access type	RW	
Default value	500	
Value range	16	2'500'000
PDO mapping	NO	
Backup	YES	

6.2.57.2 Digital incremental encoder 2 type

Defines the configuration of the digital incremental encoder 2.

Write access is only permitted in device state «Power Disable».

Name	Digital incremental encoder 2 type
Index	0x3020
Subindex	0x02
Data type	UNSIGNED16
Access type	RW
Default value	0x0001
Value range	→Table 6-115
PDO mapping	NO
Backup	YES

Bit	Name	Value	Description
15...10	reserved	0	–
9	Method	0	Speed measured as time between two consecutive sensor edges
		1	Speed measured as number of sensor edges per control cycle
8...5	reserved	0	–
4	Direction	0	maxon
		1	Inverted (or encoder mounted on motor shaft)
3...1	reserved	0	–
0	Index	0	Encoder without index (2-channel)
		1	Encoder with index (3-channel)

Table 6-115 Digital incremental encoder 2 type – Bits

6.2.57.3 Digital incremental encoder 2 index position

Holds the digital incremental encoder 2 position reached upon last detected encoder index pulse. The value is given in [increments].

Name	Digital incremental encoder 2 index position	
Index	0x3020	
Subindex	0x04	
Data type	INTEGER32	
Access type	RO	
Default value	–	
Value range	–	–
PDO mapping	TXPDO	
Backup	NO	

6.2.58 Current control parameter set

Holds the current controller parameters. The current controller is realized with a digital PI controller.

Name	Current control parameter set
Index	0x30A0
Object code	RECORD
Highest subindex supported	2

6.2.58.1 Current controller P gain

Represents the proportional gain of the current controller. The value is given in $[\frac{\mu V}{A}]$.

Name	Current controller P gain	
Index	0x30A0	
Subindex	0x01	
Data type	UNSIGNED32	
Access type	RW	
Default value	1'171'880	
Value range	–	–
PDO mapping	RXPDO	
Backup	YES	

6.2.58.2 Current controller I gain

Represents the integral gain of the current controller. The value is given in $[\frac{\mu V}{A \cdot s}]$.

Name	Current controller I gain	
Index	0x30A0	
Subindex	0x02	
Data type	UNSIGNED32	
Access type	RW	
Default value	3'906'250	
Value range	–	–
PDO mapping	RXPDO	
Backup	YES	

6.2.59 Position control parameter set

Holds the position controller parameters. The position controller is realized with a digital PID controller.

Name	Position control parameter set
Index	0x30A1
Object code	RECORD
Highest subindex supported	5

6.2.59.1 Position controller P gain

Represents the proportional gain of the position controller. The value is given in $[\frac{\mu A}{rad}]$.

Name	Position controller P gain
Index	0x30A1
Subindex	0x01
Data type	UNSIGNED32
Access type	RW
Default value	1'500'000
Value range	–
PDO mapping	RXPDO
Backup	YES

6.2.59.2 Position controller I gain

Represents the integral gain of the position controller. The value is given in $[\frac{\mu A}{rad \cdot s}]$.

Name	Position controller I gain
Index	0x30A1
Subindex	0x02
Data type	UNSIGNED32
Access type	RW
Default value	780'000
Value range	–
PDO mapping	RXPDO
Backup	YES

6.2.59.3 Position controller D gain

Represents the differential gain of the position controller. The value is given in $[\frac{\mu A \cdot s}{rad}]$.

Name	Position controller D gain	
Index	0x30A1	
Subindex	0x03	
Data type	UNSIGNED32	
Access type	RW	
Default value	16'000	
Value range	–	–
PDO mapping	RXPDO	
Backup	YES	

6.2.59.4 Position controller FF velocity gain

Represents the speed feedforward gain of the position controller. The value is given in $[\frac{\mu A \cdot s}{rad}]$.

Name	Position controller FF velocity gain	
Index	0x30A1	
Subindex	0x04	
Data type	UNSIGNED32	
Access type	RW	
Default value	0	
Value range	–	–
PDO mapping	RXPDO	
Backup	YES	

6.2.59.5 Position controller FF acceleration gain

Represents the acceleration feedforward gain of the position controller. The value is given in $[\frac{\mu A \cdot s^2}{rad}]$.

Name	Position controller FF acceleration gain	
Index	0x30A1	
Subindex	0x05	
Data type	UNSIGNED32	
Access type	RW	
Default value	0	
Value range	–	–
PDO mapping	RXPDO	
Backup	YES	

6.2.60 Velocity control parameter set

Velocity regulation is implemented with a digital PI controller. The object holds all parameters of the velocity controller.

Name	Velocity control parameter set
Index	0x30A2
Object code	RECORD
Highest subindex supported	4

6.2.60.1 Velocity controller P gain

Represents the proportional gain of the velocity controller. The value is given in $[\frac{\mu A \cdot s}{rad}]$.

Name	Velocity controller P gain
Index	0x30A2
Subindex	0x01
Data type	UNSIGNED32
Access type	RW
Default value	20'000
Value range	–
PDO mapping	RXPDO
Backup	YES

6.2.60.2 Velocity controller I gain

Represents the integral gain of the velocity controller. The value is given in $[\frac{\mu A}{rad}]$.

Name	Velocity controller I gain
Index	0x30A2
Subindex	0x02
Data type	UNSIGNED32
Access type	RW
Default value	500'000
Value range	–
PDO mapping	RXPDO
Backup	YES

6.2.60.3 Velocity controller FF velocity gain

Represents the speed feedforward gain of the velocity controller. The value is given in $[\frac{\mu A \cdot s}{rad}]$.

Name	Velocity controller FF velocity gain	
Index	0x30A2	
Subindex	0x03	
Data type	UNSIGNED32	
Access type	RW	
Default value	0	
Value range	–	–
PDO mapping	RXPDO	
Backup	YES	

6.2.60.4 Velocity controller FF acceleration gain

Represents the acceleration feedforward gain of the velocity controller. The value is given in $[\frac{\mu A \cdot s^2}{rad}]$.

Name	Velocity controller FF acceleration gain	
Index	0x30A2	
Subindex	0x04	
Data type	UNSIGNED32	
Access type	RW	
Default value	0	
Value range	–	–
PDO mapping	RXPDO	
Backup	YES	

6.2.61 Velocity observer parameter set

Velocity observation is implemented with a digital disturbance observer. The object holds all parameters of the velocity observer.

Name	Velocity observer parameter set
Index	0x30A3
Object code	RECORD
Highest subindex supported	5

6.2.61.1 Velocity observer position correction gain

Represents the position correction gain of the velocity observer. The value is given in [%].

Name	Velocity observer position correction gain	
Index	0x30A3	
Subindex	0x01	
Data type	UNSIGNED32	
Access type	RW	
Default value	400	
Value range	–	–
PDO mapping	RXPDO	
Backup	YES	

6.2.61.2 Velocity observer velocity correction gain

Represents the velocity correction gain of the velocity observer. The value is given in [mHz].

Name	Velocity observer velocity correction gain	
Index	0x30A3	
Subindex	0x02	
Data type	UNSIGNED32	
Access type	RW	
Default value	100'000	
Value range	–	–
PDO mapping	RXPDO	
Backup	YES	

6.2.61.3 Velocity observer load correction gain

Represents the load correction gain of the velocity observer. The value is given in $[\frac{\mu Nm}{rad}]$.

Name	Velocity observer load correction gain	
Index	0x30A3	
Subindex	0x03	
Data type	UNSIGNED32	
Access type	RW	
Default value	33	
Value range	–	–
PDO mapping	RXPDO	
Backup	YES	

6.2.61.4 Velocity observer friction

Represents the velocity observer friction. The value is given in $[0.001 \cdot \frac{\mu Nm}{rpm}]$.

Name	Velocity observer friction	
Index	0x30A3	
Subindex	0x04	
Data type	UNSIGNED32	
Access type	RW	
Default value	10	
Value range	–	–
PDO mapping	RXPDO	
Backup	YES	

6.2.61.5 Velocity observer inertia

Represents the velocity observer inertia. The value is given in $[0.001 g \cdot cm^2]$.

Name	Velocity observer inertia	
Index	0x30A3	
Subindex	0x05	
Data type	UNSIGNED32	
Access type	RW	
Default value	1000	
Value range	–	–
PDO mapping	RXPDO	
Backup	YES	

6.2.62 Dual loop position control parameter set

Dual loop position control is implemented with a P main loop (outer loop) controller, a gain scheduler, additional filters, and an auxiliary loop (inner loop) PI speed controller with velocity observer. The object holds all mandatory parameters for the configuration.

Name	Dual loop position control parameter set
Index	0x30AE
Object code	RECORD
Highest subindex supported	64

6.2.62.1 Main loop P gain low bandwidth

Represents the main loop low bandwidth proportional factor. The value is given in $[10^{-3}\frac{1}{s}]$.

Name	Main loop P gain low bandwidth	
Index	0x30AE	
Subindex	0x01	
Data type	UNSIGNED32	
Access type	RW	
Default value	10'000	
Value range	0	10^9
PDO mapping	RXPDO	
Backup	YES	

6.2.62.2 Main loop P gain high bandwidth

Represents the main loop high bandwidth proportional factor. The value is given in $[10^{-3}\frac{1}{s}]$.

Name	Main loop P gain high bandwidth	
Index	0x30AE	
Subindex	0x02	
Data type	UNSIGNED32	
Access type	RW	
Default value	100'000	
Value range	0	10^9
PDO mapping	RXPDO	
Backup	YES	

6.2.62.3 Main loop gain scheduling weight

Represents the main loop gain scheduler. The value is given in $[10^{-3}]$.

Name	Main loop gain scheduling weight	
Index	0x30AE	
Subindex	0x03	
Data type	UNSIGNED16	
Access type	RW	
Default value	12'500	
Value range	5'000	20'000
PDO mapping	RXPDO	
Backup	YES	

6.2.62.4 Main loop filter coefficient A

Represents the main loop filter coefficient A. The value is given in $[10^{-3}]$.

The internal filter coefficients are not updated until the filter update bit in →Dual loop configuration miscellaneous (0x30AE; 0x40) is written.

Name	Main loop filter coefficient A	
Index	0x30AE	
Subindex	0x10	
Data type	UNSIGNED32	
Access type	RW	
Default value	1'000	
Value range	0	10^9
PDO mapping	RXPDO	
Backup	YES	

6.2.62.5 Main loop filter coefficient B

Represents the main loop filter coefficient B. The value is given in $[10^{-3}]$.

The internal filter coefficients are not updated until the filter update bit in →Dual loop configuration miscellaneous (0x30AE; 0x40) is written.

Name	Main loop filter coefficient B	
Index	0x30AE	
Subindex	0x11	
Data type	UNSIGNED32	
Access type	RW	
Default value	1'000	
Value range	0	10^9
PDO mapping	RXPDO	
Backup	YES	

6.2.62.6 Main loop filter coefficient C

Represents the main loop filter coefficient C. The value is given in $[10^{-3}]$.

The internal filter coefficients are not updated until the filter update bit in →Dual loop configuration miscellaneous (0x30AE; 0x40) is written.

Name	Main loop filter coefficient C	
Index	0x30AE	
Subindex	0x12	
Data type	UNSIGNED32	
Access type	RW	
Default value	1'000	
Value range	0	10^9
PDO mapping	RXPDO	
Backup	YES	

6.2.62.7 Main loop filter coefficient D

Represents the main loop filter coefficient D. The value is given in $[10^{-3}]$.

The internal filter coefficients are not updated until the filter update bit in →Dual loop configuration miscellaneous (0x30AE; 0x40) is written.

Name	Main loop filter coefficient D	
Index	0x30AE	
Subindex	0x13	
Data type	UNSIGNED32	
Access type	RW	
Default value	1'000	
Value range	0	10^9
PDO mapping	RXPDO	
Backup	YES	

6.2.62.8 Main loop filter coefficient E

Represents the main loop filter coefficient E. The value is given in $[10^{-3}]$.

The internal filter coefficients are not updated until the filter update bit in →Dual loop configuration miscellaneous (0x30AE; 0x40) is written.

Name	Main loop filter coefficient E	
Index	0x30AE	
Subindex	0x14	
Data type	UNSIGNED32	
Access type	RW	
Default value	1'000	
Value range	0	10^9
PDO mapping	RXPDO	
Backup	YES	

6.2.62.9 Auxiliary loop P gain

Represents the proportional gain of the auxiliary loop velocity controller. The value is given in $[\frac{\mu A \cdot s}{rad}]$.

Name	Auxiliary loop P gain	
Index	0x30AE	
Subindex	0x20	
Data type	UNSIGNED32	
Access type	RW	
Default value	20'000	
Value range	–	–
PDO mapping	RXPDO	
Backup	YES	

6.2.62.10 Auxiliary loop I gain

Represents the integral gain of the auxiliary loop velocity controller. The value is given in $[\frac{\mu A}{rad}]$.

Name	Auxiliary loop I gain	
Index	0x30AE	
Subindex	0x21	
Data type	UNSIGNED32	
Access type	RW	
Default value	500'000	
Value range	–	–
PDO mapping	RXPDO	
Backup	YES	

6.2.62.11 Auxiliary loop FF velocity gain

Represents the speed feedforward gain of the auxiliary loop velocity controller. The value is given in $[\frac{\mu A \cdot s}{rad}]$.

Name	Auxiliary loop FF velocity gain	
Index	0x30AE	
Subindex	0x22	
Data type	UNSIGNED32	
Access type	RW	
Default value	0	
Value range	–	–
PDO mapping	RXPDO	
Backup	YES	

6.2.62.12 Auxiliary loop FF acceleration gain

Represents the acceleration feedforward gain of the auxiliary loop velocity controller. The value is given

in $[\frac{\mu A \cdot s^2}{rad}]$.

Name	Auxiliary loop FF acceleration gain	
Index	0x30AE	
Subindex	0x23	
Data type	UNSIGNED32	
Access type	RW	
Default value	0	
Value range	–	–
PDO mapping	RXPDO	
Backup	YES	

6.2.62.13 Auxiliary loop observer position correction gain

Represents the position correction gain of the auxiliary loop velocity observer. The value is given in [‰].

Name	Auxiliary loop observer position correction gain	
Index	0x30AE	
Subindex	0x30	
Data type	UNSIGNED32	
Access type	RW	
Default value	400	
Value range	–	–
PDO mapping	RXPDO	
Backup	YES	

6.2.62.14 Auxiliary loop observer velocity correction gain

Represents the velocity correction gain of the auxiliary loop velocity observer. The value is given in [mHz].

Name	Auxiliary loop observer velocity correction gain	
Index	0x30AE	
Subindex	0x31	
Data type	UNSIGNED32	
Access type	RW	
Default value	100'000	
Value range	–	–
PDO mapping	RXPDO	
Backup	YES	

6.2.62.15 Auxiliary loop observer load correction gain

Represents the load correction gain of the auxiliary loop velocity observer. The value is given in $[\frac{\mu Nm}{rad}]$.

Name	Auxiliary loop observer load correction gain	
Index	0x30AE	
Subindex	0x32	
Data type	UNSIGNED32	
Access type	RW	
Default value	33	
Value range	–	–
PDO mapping	RXPDO	
Backup	YES	

6.2.62.16 Auxiliary loop observer friction

Represents the auxiliary loop velocity observer friction. The value is given in $[0.001 \cdot \frac{\mu Nm}{rpm}]$.

Name	Auxiliary loop observer friction	
Index	0x30AE	
Subindex	0x33	
Data type	UNSIGNED32	
Access type	RW	
Default value	10	
Value range	–	–
PDO mapping	RXPDO	
Backup	YES	

6.2.62.17 Auxiliary loop observer inertia

Represents the auxiliary loop velocity observer inertia. The value is given in $[mg \cdot cm^2]$.

Name	Auxiliary loop observer inertia	
Index	0x30AE	
Subindex	0x34	
Data type	UNSIGNED32	
Access type	RW	
Default value	1'000	
Value range	–	–
PDO mapping	RXPDO	
Backup	YES	

6.2.62.18 Dual loop configuration miscellaneous

Used to define various options regarding the axis configuration.

Name	Dual loop configuration miscellaneous
Index	0x30AE
Subindex	0x40
Data type	UNSIGNED16
Access type	RW
Default value	0x0000
Value range	→Table 6-116
PDO mapping	RXPDO
Backup	YES

Bit	Name	Value	Description
15...2	reserved	0	–
1	Main loop filter active	1	Filter functionality is enabled
		0	Filter functionality is disabled
0	Main loop filter update	1	Writing a “1” forces an internal update of the filter coefficients. Always read as “0” (zero).
		0	Has no effect

Table 6-116 Dual loop configuration miscellaneous – Bits

6.2.63 Home position

Defines the position that will be set as zero position of the absolute position counter. The value is given in [position units] (→page 2-16).

Related objects: →“Home offset move distance” on page 6-178

Name	Home position
Index	0x30B0
Subindex	0x00
Data type	INTEGER32
Access type	RW
Default value	0
Value range	–
PDO mapping	RXPDO
Backup	YES

6.2.64 Home offset move distance

Represents a moving distance in a homing procedure. It is useful to move away from a detected position (for example mechanical limit stop or limit switch) at the end of the homing sequence, thus preventing the axis from a border damage respectively limit switch error.

Name	Home offset move distance	
Index	0x30B1	
Subindex	0x00	
Data type	INTEGER32	
Access type	RW	
Default value	0	
Value range	–	–
PDO mapping	NO	
Backup	YES	

6.2.65 Current threshold for homing mode

Used for homing modes «-1», «-2», «-3», and «-4». A mechanical border will be detected when the measured motor current rises above the specified threshold [mA].

Name	Current threshold for homing mode	
Index	0x30B2	
Subindex	0x00	
Data type	UNSIGNED16	
Access type	RW	
Default value	500	
Value range	–	Maximal value of →Nominal current
PDO mapping	RXPDO	
Backup	YES	

6.2.66 Current demand value

The set value for the current controller. The value is given in [mA].

Name	Current demand value	
Index	0x30D0	
Subindex	0x00	
Data type	INTEGER32	
Access type	RO	
Default value	–	
Value range	–	–
PDO mapping	TXPDO	
Backup	NO	

6.2.67 Current actual values

Provides the actual current values.

Name	Current actual values
Index	0x30D1
Object code	ARRAY
Highest subindex supported	2

6.2.67.1 Current actual value averaged

Represents the →“Current actual value” on page 6-179 filtered by 1st order digital low-pass filter with a cut-off frequency of 50 Hz. The value is given in [mA].

Name	Current actual value averaged
Index	0x30D1
Subindex	0x01
Data type	INTEGER32
Access type	RO
Default value	–
Value range	–
PDO mapping	TXPDO
Backup	NO

6.2.67.2 Current actual value

Provides the actual value of the motor's current. The value is given in [mA].

Name	Current actual value
Index	0x30D1
Subindex	0x02
Data type	INTEGER32
Access type	RO
Default value	–
Value range	–
PDO mapping	TXPDO
Backup	NO

6.2.68 Torque actual values

Provides the actual torque values.

Name	Torque actual values
Index	0x30D2
Object code	ARRAY
Highest subindex supported	1

6.2.68.1 Torque actual value averaged

Represents the →“Torque actual value” on page 6-206 filtered by 1st order digital low-pass filter with a cut-off frequency of 50 Hz. The value is given in $[\frac{MotorRatedTorque}{1000}]$.

Related objects: →“Torque actual value” on page 6-206

Name	Torque actual value averaged	
Index	0x30D2	
Subindex	0x01	
Data type	INTEGER16	
Access type	RO	
Default value	–	
Value range	–	–
PDO mapping	TXPDO	
Backup	NO	

6.2.69 Velocity actual values

Provides the actual velocity values.

Name	Velocity actual values
Index	0x30D3
Object code	ARRAY
Highest subindex supported	1

6.2.69.1 Velocity actual value averaged

Represents the →“Velocity actual value” on page 6-205 filtered by 1st order digital low-pass filter with a cut-off frequency of 5 Hz.

Provides the actual averaged velocity value of the axis, derived by the main sensor defined in →“Axis configuration” on page 6-132. If no main sensor is configured, the velocity actual value is “0” (zero). The value is given in [velocity units] (→page 2-16).

Related objects: →“Velocity actual value” on page 6-205 / →“Additional velocity actual values” on page 6-222

Name	Velocity actual value averaged	
Index	0x30D3	
Subindex	0x01	
Data type	INTEGER32	
Access type	RO	
Default value	–	
Value range	–	–
PDO mapping	TXPDO	
Backup	NO	

6.2.70 Standstill window configuration

Configures the conditions to detect when the drive has come to a standstill. The functionality specifies the behavior of some device state machine transitions (→“Device Control” on page 2-13).

The following transitions are not performed until standstill condition is reached:

- «Operation Enable» → «Switch on disabled»
- «Operation Enable» → «Ready to switch on»
- «Operation Enable» → «Switched on»
- «Fault reaction active» → «Fault»

The slowdown behavior can be configured using the related objects.

Related objects: →“Abort connection option code” on page 6-197 / →“Shutdown option code” on page 6-201 / →“Disable operation option code” on page 6-202 / →“Fault reaction option code” on page 6-202

Name	Standstill window configuration
Index	0x30E0
Object code	RECORD
Highest subindex supported	3

6.2.70.1 Standstill window

Defines a symmetric range of accepted velocity values relatively to zero.

Standstill is reached, if the →“Velocity actual value averaged” on page 6-181 is within the standstill window (0x01) for the duration of the standstill window time (0x02). The value is given in [velocity units] (→page 2-16).

The value “4'294'967'295” ($2^{32}-1$) switches off standstill detection and standstill is deemed to be reached at the end of the trajectory.

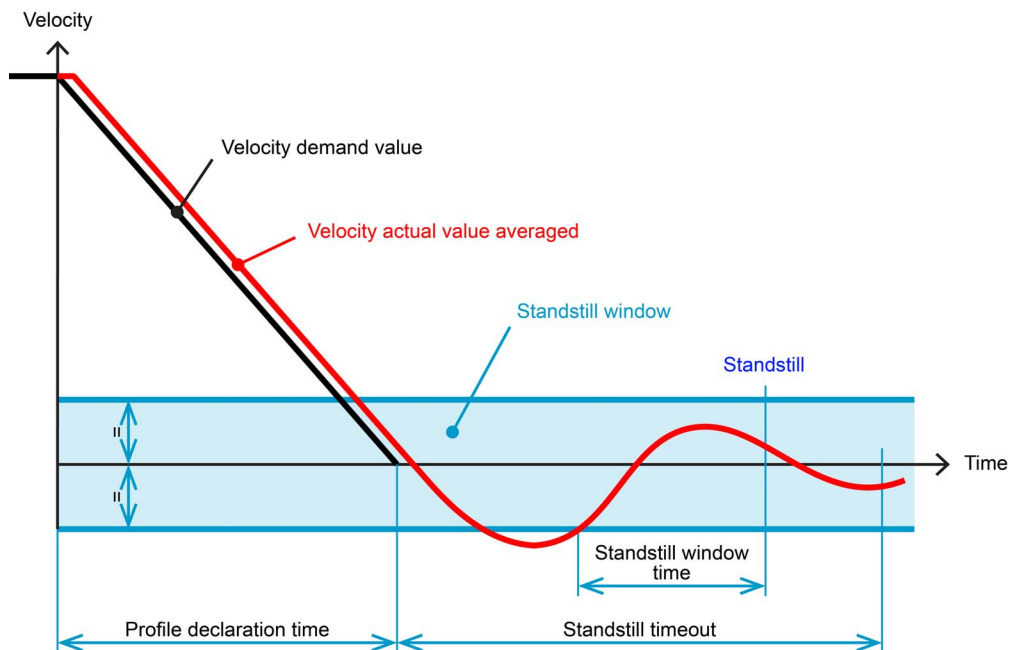

Figure 6-45 Standstill window

Continued on next page.

Name	Standstill window	
Index	0x30E0	
Subindex	0x01	
Data type	UNSIGNED32	
Access type	RW	
Default value	30	
Value range	–	–
PDO mapping	NO	
Backup	YES	

6.2.70.2 Standstill window time

Standstill is reached, if the →“Velocity actual value averaged” on page 6-181 is within the standstill window (0x01) for the duration of the standstill window time (0x02). The value is given in [ms].

Name	Standstill window time	
Index	0x30E0	
Subindex	0x02	
Data type	UNSIGNED16	
Access type	RW	
Default value	2	
Value range	–	–
PDO mapping	NO	
Backup	YES	

6.2.70.3 Standstill window timeout

Defines the point of time standstill is supposed to be reached, even if the standstill conditions are not yet fulfilled. This timeout may be used to prevent “hangs” in the device state machine in case the standstill window configuration or the velocity controller parameters are set inauspicious. The value is given in [ms].

The value “65'535” will disable the timeout.

Name	Standstill window timeout	
Index	0x30E0	
Subindex	0x03	
Data type	UNSIGNED16	
Access type	RW	
Default value	1000	
Value range	–	–
PDO mapping	NO	
Backup	YES	

6.2.71 Digital input properties

Related objects: →“Configuration of digital inputs” on page 6-185 / →“Digital inputs” on page 6-225

Name	Digital input properties
Index	0x3141
Object code	ARRAY
Highest subindex supported	2

6.2.71.1 Digital inputs logic state

Displays the state of the digital input logic signal (before polarity correction). A bit is read as “1” if the signal at the corresponding pin is high.

Name	Digital inputs logic state
Index	0x3141
Subindex	0x01
Data type	UNSIGNED16
Access type	RO
Default value	–
Value range	–
PDO mapping	TXPDO
Backup	NO

Bit	Default value
7	High-speed digital input 4
6	High-speed digital input 3
5	High-speed digital input 2
4	High-speed digital input 1
3	Digital input 4
2	Digital input 3
1	Digital input 2
0	Digital input 1

Table 6-117 Digital input bits

6.2.71.2 Digital inputs polarity

Used to set the polarity of the digital input functionalities. If a bit is set to “0” (zero), the associated pin is high active. For bit description → Table 6-117.

Name	Digital inputs polarity
Index	0x3141
Subindex	0x02
Data type	UNSIGNED16
Access type	RW
Default value	0x0000
Value range	–
PDO mapping	NO
Backup	YES

6.2.72 Configuration of digital inputs

Configures the functionality that will be assigned to digital inputs.

Related objects: →“Digital input properties” on page 6-184 / →“Digital inputs” on page 6-225

Name	Configuration of digital inputs
Index	0x3142
Object code	ARRAY
Highest subindex supported	8

6.2.72.1 Digital input configuration

Maps functions to digital inputs. Each function can only be mapped once, each digital input can only hold one function.

Names	Digital input 1 configuration Digital input 2 configuration Digital input 3 configuration Digital input 4 configuration High-speed digital input 1 configuration High-speed digital input 2 configuration High-speed digital input 3 configuration High-speed digital input 4 configuration
Index	0x3142
Subindex	0x01...0x08
Data type	UNSIGNED8
Access type	RW
Default value	→Table 6-118
Value range	→Table 6-118
PDO mapping	NO
Backup	YES

Digital input	Default value
DgIn1	0: Negative limit switch
DgIn2	1: Positive limit switch
DgIn3	2: Home switch
DgIn4	19: General purpose D
HsDgIn1	255: none
HsDgIn2	255: none
HsDgIn3	255: none
HsDgIn4	255: none

Table 6-118 Digital inputs – Default values

Continued on next page.

Value	Functionality	Description
255	None	No functionality assigned
254...29	reserved	–
28	Quick stop	Stop movement and switch to «Quick stop active» state (→“Device Control” on page 2-13 for valid transitions)
27	Drive enable	Enable/disable the drive or clear errors in «Fault» state (→“Device Control” on page 2-13 for valid transitions)
26	reserved	–
25	Positive limit switch without errors	Used in some homing modes / does not generate limit errors
24	Negative limit switch without errors	Used in some homing modes / does not generate limit errors
23	General purpose H	State can be read
22	General purpose G	State can be read
21	General purpose F	State can be read
20	General purpose E	State can be read
19	General purpose D	State can be read
18	General purpose C	State can be read
17	General purpose B	State can be read
16	General purpose A	State can be read
15...3	reserved	–
2	Home switch	Used in some homing modes
1	Positive limit switch	Used in some homing modes / generates limit error
0	Negative limit switch	Used in some homing modes / generates limit error

Table 6-119 Digital inputs – Configuration

6.2.73 Digital output properties

Related objects: →“Configuration of digital outputs” on page 6-188 / →“Digital outputs” on page 6-226

Name	Digital output properties
Index	0x3150
Object code	ARRAY
Highest subindex supported	2

6.2.73.1 Digital outputs logic state

Displays the digital output logic state (after polarity correction). A bit is read as “1” if the signal at the corresponding pin is high.

Name	Digital outputs logic state
Index	0x3150
Subindex	0x01
Data type	UNSIGNED16
Access type	RO
Default value	–
Value range	–
PDO mapping	TXPDO
Backup	NO

Bit	Description
2	High-speed digital output1
1	Digital output 2
0	Digital output 1

Table 6-120 Digital output bits

6.2.73.2 Digital outputs polarity

Used to set the polarity of the digital outputs. If a bit is set to “1”, the associated output will be inverted, thus “1” in →“Digital outputs” on page 6-226” will set the output pin low.

For bit description →Table 6-120.

Name	Digital outputs polarity
Index	0x3150
Subindex	0x02
Data type	UNSIGNED16
Access type	RW
Default value	0x0000
Value range	–
PDO mapping	NO
Backup	YES

6.2.74 Configuration of digital outputs

Configures the functionality that will be assigned to digital outputs 1 to 3.

Related objects: →“Digital output properties” on page 6-187 / →“Digital outputs” on page 6-226

Name	Configuration of digital outputs
Index	0x3151
Object code	ARRAY
Highest subindex supported	3

6.2.74.1 Digital output configuration

Names	Digital output 1 configuration Digital output 2 configuration High-speed digital output 1 configuration
Index	0x3151
Subindex	0x01...0x03
Data type	UNSIGNED8
Access type	RW
Default value	→Table 6-121
Value range	→Table 6-122
PDO mapping	NO
Backup	YES

Digital output	Default value
DigOut1	16: General purpose A
DigOut2	17: General purpose B
HsDigOut1	255: None

Table 6-121 Digital outputs – Default values

Value	Functionality	Description
255	None	No functionality assigned
254...26	reserved	–
25	Ready/Fault	Active on device ready / inactive on device fault state
24	Holding brake	Output functionality to drive a holding brake (for details → “Holding brake parameters” on page 6-189)
23...19	reserved	–
18	General purpose C	State can be read/written by the host
17	General purpose B	State can be read/written by the host
16	General purpose A	State can be read/written by the host
15...1	reserved	–
0	Set brake (GPIO)	To drive a brake operated by the host in conformance to CiA 402 specification

Table 6-122 Digital outputs – Configuration

6.2.75 Holding brake parameters

Holding brakes are designed to provide protection against unintentional drifting at standstill. They are activated when no torque is applied to the motor. If the controller applies torque to the motor, the holding brake is deactivated (→chapter “2.2 Device Control” on page 2-13).

The functionality can be mapped to any digital output (→“Configuration of digital inputs” on page 6-185). Thereby, take the output current limit into account (for details →separate document «Hardware Reference» of respective controller).

DESIGN CHARACTERISTICS OF HOLDING BRAKE

- The holding brake is not designed to brake loads. This is done by the controller.
- The holding brake or the motor may be damaged if the holding brake will activate before the motor has reached full standstill. Thus, it is of vital importance to configure the standstill conditions (→“Standstill window configuration” on page 6-182)!
- The holding brake function will only work properly if a main sensor is configured. Otherwise, there is no available information on the motor speed and, as a consequence thereof, there is no possibility to detect standstill →“Standstill window configuration” on page 6-182 and →“Control structure” on page 6-134).

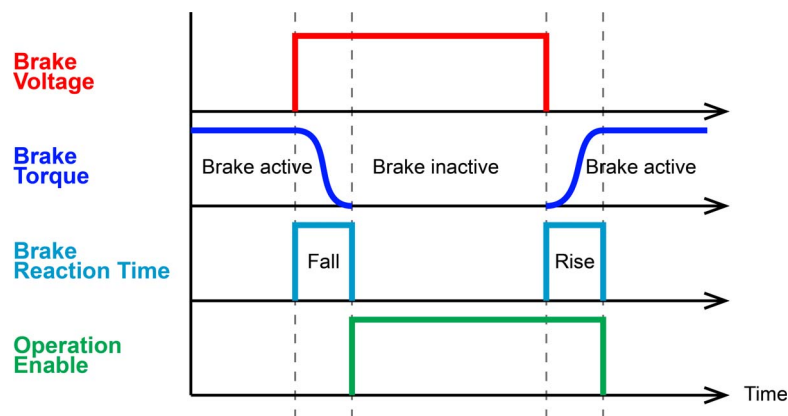

Figure 6-46 Holding brake activation timing (digital output polarity “High active”)

Name	Holding brake parameters
Index	0x3158
Object code	ARRAY
Highest subindex supported	2

Continued on next page.

6.2.75.1 Holding brake rise time

Indicates the time required from power-off until reaching the holding brake's torque (→Figure 6-46). The value is given in [ms].

Name	Holding brake rise time	
Index	0x3158	
Subindex	0x01	
Data type	UNSIGNED16	
Access type	RW	
Default value	10	
Value range	0	5'000
PDO mapping	NO	
Backup	YES	

6.2.75.2 Holding brake fall time

Indicates the time required from power-on until releasing the holding brake's torque (→Figure 6-46). The value is given in [ms].

Name	Holding brake fall time	
Index	0x3158	
Subindex	0x02	
Data type	UNSIGNED16	
Access type	RW	
Default value	10	
Value range	0	5'000
PDO mapping	NO	
Backup	YES	

6.2.76 Analog input properties

Name	Analog input properties
Index	0x3160
Object code	ARRAY
Highest subindex supported	2

6.2.76.1 Analog input n voltage

Represents the voltage measured at analog inputs. The value is given in [mV].

Names	Analog input 1 voltage Analog input 2 voltage	
Index	0x3160	
Subindex	0x01...0x02	
Data type	INTEGER16	
Access type	RO	
Default value	-	
Value range	-	-
PDO mapping	TXPDO	
Backup	NO	

6.2.77 Analog input adjustment

Name	Analog input adjustment
Index	0x3163
Object code	RECORD
Highest subindex supported	4

6.2.77.1 Analog input *n* adjustment offset

Represents the adjustment offset voltage of an analog input. The value is given in [mV].

Names	Analog input 1 adjustment offset Analog input 2 adjustment offset	
Index	0x3163	
Subindex	0x01, 0x03	
Data type	INTEGER16	
Access type	RW	
Default value	0	
Value range	-1'000	1'000
PDO mapping	NO	
Backup	YES	

6.2.77.2 Analog input *n* adjustment gain factor

Represents the adjustment gain factor of an analog input.

Names	Analog input 1 adjustment gain factor Analog input 2 adjustment gain factor	
Index	0x3163	
Subindex	0x02, 0x04	
Data type	UNSIGNED16	
Access type	RW	
Default value	10'000	
Value range	5'000	20'000
PDO mapping	NO	
Backup	YES	

6.2.78 Analog output properties

Name	Analog output properties
Index	0x3180
Object code	ARRAY
Highest subindex supported	2

6.2.78.1 Analog output n voltage

Represents the voltage output at analog outputs. The value is given in [mV].

Names	Analog output 1 voltage Analog output 2 voltage	
Index	0x3180	
Subindex	0x01, 0x02	
Data type	INTEGER16	
Access type	RO	
Default value	-	
Value range	-	-
PDO mapping	TXPDO	
Backup	NO	

6.2.79 Configuration of analog outputs

Configures the functionality that will be assigned to analog outputs.

Name	Configuration of analog outputs
Index	0x3181
Object code	ARRAY
Highest subindex supported	2

6.2.79.1 Analog output configuration

Names	Analog output 1 configuration Analog output 2 configuration
Index	0x3181
Subindex	0x01, 0x02
Data type	UNSIGNED8
Access type	RW
Default value	→ Table 6-123
Value range	→ Table 6-124
PDO mapping	NO
Backup	YES

Analog output	Default value
AnlgOut1	0: General purpose A
AnlgOut2	1: General purpose B

Table 6-123 Analog outputs – Default values

Value	Functionality	Description
255	None	No functionality assigned
254...2	reserved	–
1	General purpose B	Value can be read/written by the host
0	General purpose A	Value can be read/written by the host

Table 6-124 Analog outputs – Configuration

6.2.80 Analog output general purpose

Used to set the actual voltage on the analog outputs. Write to this object has only an effect if the analog output is configured as general purpose. The value is given in [mV].

Related objects: → "Analog output properties" on page 6-193

Name	Analog output general purpose
Index	0x3182
Object code	ARRAY
Highest subindex supported	2

6.2.80.1 Analog output general purpose n

Names	Analog output general purpose A Analog output general purpose B	
Index	0x3182	
Subindex	0x01, 0x02	
Data type	INTEGER16	
Access type	RW	
Default value	0	
Value range	-4'000	4'000
PDO mapping	RXPDO	
Backup	YES	

6.2.81 Motor protection

Represents the motor protection parameters.

Name	Motor protection
Index	0x3200
Object code	RECORD
Highest subindex supported	2

6.2.81.1 I2t level motor

Provides the actual thermal state of the internal i2t motor protection feature. The number is given in per cent but values higher than 100% are possible.

Name	I2t level motor	
Index	0x3200	
Subindex	0x01	
Data type	UNSIGNED16	
Access type	RO	
Default value	-	
Value range	-	-
PDO mapping	TXPDO	
Backup	NO	

6.2.81.2 I2t level controller

Provides the actual thermal state of the internal i2t motor protection feature. The number is given in per cent but values higher than 100% are possible.

Name	I2t level controller	
Index	0x3200	
Subindex	0x02	
Data type	UNSIGNED16	
Access type	RO	
Default value	-	
Value range	-	-
PDO mapping	TXPDO	
Backup	NO	

6.2.82 Thermal controller protection

Handles the power stage.

Name	Thermal controller protection
Index	0x3201
Object code	RECORD
Highest subindex supported	1

6.2.82.1 Temperature power stage

Displays the power stage temperature. The value is given in [0.1 C°].

Name	Temperature power stage
Index	0x3201
Subindex	0x01
Data type	INTEGER16
Access type	RO
Default value	–
Value range	–
PDO mapping	NO
Backup	NO

6.2.83 Abort connection option code

Specifies the action that will be performed when one of the errors labeled “a” (→“Device Errors” on page 7-237) will be detected. It contains all communication errors.

Some critical errors labeled “d” (→“Device Errors” on page 7-237) always lead to a Disable command even if the fault reaction was not configured to do so.

Related objects: →“Error register” on page 6-66 / →“Fault reaction option code” on page 6-202

Name	Abort connection option code	
Index	0x6007	
Subindex	0x00	
Data type	INTEGER16	
Access type	RW	
Default value	3	
Value range	2	3
PDO mapping	NO	
Backup	YES	

Value	Description
2	«Disable voltage» command
3	«Quick stop» command

Table 6-125 Abort connection option code

6.2.84 Error code

Provides the error code of the last error that occurred in the device. This value differs from the value in object →“Error register” on page 6-66. Yet, it is the value that will also appear in object →“Error history” on page 6-67.

Name	Error code	
Index	0x603F	
Subindex	0x00	
Data type	UNSIGNED16	
Access type	RO	
Default value	-	
Value range	-	-
PDO mapping	TXPDO	
Backup	NO	

6.2.85 Controlword

Comprises bits for the following items:

- → “Device Control Commands” on page 2-15 (bits 0...3, 7)
- Supervision of operating modes (bits 4...6, 8):
 - “Controlword (Profile Position Mode-specific Bits)” on page 3-23
 - “Controlword (Profile Velocity Mode-specific Bits)” on page 3-26
 - “Controlword (Homing Mode-specific Bits)” on page 3-29

For bit patterns of triggered commands → chapter “2.2.3 Device Control Commands” on page 2-15.

Related objects: → “Statusword” on page 6-200

Name	Controlword	
Index	0x6040	
Subindex	0x00	
Data type	UNSIGNED16	
Access type	RW	
Default value	–	
Value range	–	–
PDO mapping	RXPDO	
Backup	NO	

Bit	Description	PPM	PVM	HMM	CSP	CSV	CST
15	Operating mode-specific	Endless movement	reserved	reserved	reserved	reserved	reserved
14...11	reserved						
10, 9	reserved						
8	Operating mode-specific	Halt	Halt	Halt			
7	Fault reset						
6	Operating mode-specific	Abs / rel	reserved	reserved			
5	Operating mode-specific	Change set immediately	reserved	reserved			
4	Operating mode-specific	New setpoint	reserved	Homing operation start			
3	Enable operation						
2	Quick stop						
1	Enable voltage						
0	Switched on						

Table 6-126 Controlword bits

6.2.86 Statusword

Comprises bits for the following items:

- →“State of the Drive” on page 2-14 (bits 0...6)
- Operating state of the mode (bits 10, 12 and 13):
 - “Statusword (Profile Position Mode-specific Bits)” on page 3-24
 - “Statusword (Profile Velocity Mode-specific Bits)” on page 3-27
 - “Statusword (Homing Mode-specific Bits)” on page 3-30
 - “Statusword (Cyclic Synchronous Position Mode-specific Bits)” on page 3-40
 - “Statusword (Cyclic Synchronous Torque Mode-specific Bits)” on page 3-46
- Position referenced to home position (bit 15: will be set on homing attained and will be cleared on a position counter overflow or a position sensor error)
- Internal limit active (bit 11: signals the output current limitation according to I2t method or velocity demand is limited in Profile Velocity Mode)
- Remote (bit 9: indicates NMT state is «Operational»)
- Warning (bit 7: indicates the presence of a warning condition)

Related objects: →“Controlword” on page 6-199

Name	Statusword
Index	0x6041
Subindex	0x00
Data type	UNSIGNED16
Access type	RO
Default value	–
Value range	–
PDO mapping	TXPDO
Backup	NO

Bit	Description	PPM	PVM	HMM	CSP	CSV	CST
15	Position referenced to home position						
14	reserved (0)						
13	Operating mode-specific	Following error	Not used	Homing error	Following error		
12	Operating mode-specific	Setpoint acknowledge	Speed	Homing attained	Drive follows command value	Drive follows command value	Drive follows command value
11	Internal limit active		Speed is limited				
10	Operating mode-specific	Target reached	Target reached	Target reached	reserved	reserved	reserved
9	Remote						
8	reserved (0)						
7	Warning						
6	Switch on disabled						
5	Quick stop						
4	Voltage enabled (power stage on)						
3	Fault						

Continued on next page.

Bit	Description	PPM	PVM	HMM	CSP	CSV	CST
2	Operation enabled						
1	Switched on						
0	Ready to switch on						

Table 6-127 Statusword bits

6.2.87 Quick stop option code

Indicates the action that will be performed as «Quick stop» is executed.

Name	Quick stop option code	
Index	0x605A	
Subindex	0x00	
Data type	INTEGER16	
Access type	RW	
Default value	6	
Value range	6	6
PDO mapping	NO	
Backup	YES	

Value	Description
6	Decelerate with quick stop ramp and stay in «Quick stop active», enabled

Table 6-128 Quick stop option code

6.2.88 Shutdown option code

Indicates the action that will be performed during transition from state «Operation enabled» to states «Ready to switch on» or «Switch on disabled».

Name	Shutdown option code	
Index	0x605B	
Subindex	0x00	
Data type	INTEGER16	
Access type	RW	
Default value	0	
Value range	0	1
PDO mapping	NO	
Backup	YES	

Value	Description
1	Decelerate with slowdown ramp; disabling of the drive function
0	Disable drive function (switch-off the power stage)

Table 6-129 Shutdown option code

6.2.89 Disable operation option code

Indicates the action that will be performed during transition from state «Operation enabled» to state «Switched on».

Name	Disable operation option code	
Index	0x605C	
Subindex	0x00	
Data type	INTEGER16	
Access type	RW	
Default value	1	
Value range	0	1
PDO mapping	NO	
Backup	YES	

Value	Description
1	Decelerate with slowdown ramp; disabling of the drive function
0	Disable drive function (switch-off the power stage)

Table 6-130 Disable operation option code

6.2.90 Fault reaction option code

Specifies the action to be performed if one of the errors labeled “f” in the →“Device Errors” on page 7-237 will be detected. It contains most errors except communication errors (handled as to →“Abort connection option code” on page 6-197).

Some critical errors (labeled “d” (→“Device Errors” on page 7-237) always lead to a disable command even if the fault reaction was not configured to do so.

Related objects: →“Error register” on page 6-66 / →“Abort connection option code” on page 6-197

Name	Fault reaction option code	
Index	0x605E	
Subindex	0x00	
Data type	INTEGER16	
Access type	RW	
Default value	2	
Value range	0	2
PDO mapping	NO	
Backup	YES	

Value	Description
2	Slow down with quick stop ramp
1	Slow down with slowdown ramp
0	Disable drive function

Table 6-131 Fault reaction option code

6.2.91 Modes of operation

Switches the actually chosen operating mode. We recommend to use → Modes of operation display after changing the operation mode.

Related objects: → "Modes of operation display" on page 6-203

Name	Modes of operation
Index	0x6060
Subindex	0x00
Data type	INTEGER8
Access type	RW
Default value	1
Value range	→ Table 6-132
PDO mapping	RXPDO
Backup	YES

Operation mode	Description
1	→ Profile Position Mode (PPM)
3	→ Profile Velocity Mode (PVM)
6	→ Homing Mode (HMM)
8	→ Cyclic Synchronous Position Mode (CSP)
9	→ Cyclic Synchronous Velocity Mode (CSV)
10	→ Cyclic Synchronous Torque Mode (CST)

Table 6-132 Modes of operation

6.2.92 Modes of operation display

Displays the actual mode of operation. The meaning of the returned value corresponds to the code in → Table 6-132.

Related objects: → "Modes of operation" on page 6-203

Name	Modes of operation display
Index	0x6061
Subindex	0x00
Data type	INTEGER8
Access type	RO
Default value	–
Value range	→ Table 6-132
PDO mapping	TXPDO
Backup	NO

6.2.93 Position demand value

Used as input for the position controller. For profiled motions, the value is generated by the profile generator. The value is given in [position units] (→page 2-16).

Name	Position demand value	
Index	0x6062	
Subindex	0x00	
Data type	INTEGER32	
Access type	RO	
Default value	–	
Value range	–	–
PDO mapping	TXPDO	
Backup	NO	

6.2.94 Position actual value

Provides the actual position value of the axis, derived by the main sensor defined in →“Axis configuration” on page 6-132. The value is given in [position units] (→page 2-16).

- As soon as a homing procedure is successfully performed, the value is absolute and referenced which is indicated by the «Position referenced to home position» bit →“Statusword” on page 6-200
- If no main sensor is configured, the position actual value is always “0” (zero).

Related objects: →“Additional position actual values” on page 6-221

Name	Position actual value	
Index	0x6064	
Subindex	0x00	
Data type	INTEGER32	
Access type	RO	
Default value	–	
Value range	–	–
PDO mapping	TXPDO	
Backup	NO	

6.2.95 Following error window

Represents the maximal permitted difference between →“Position actual value” on page 6-204 and →“Position demand value” on page 6-204. If exceeded, a following error will occur. The value is given in [position units] (→page 2-16).

Name	Following error window	
Index	0x6065	
Subindex	0x00	
Data type	UNSIGNED32	
Access type	RW	
Default value	2000	
Value range	–	–
PDO mapping	RXPDO	
Backup	YES	

6.2.96 Following error timeout

Indicates the configured time for a following error condition. If exceeded, a following error will occur. The value is given in milliseconds [ms].

Name	Following error timeout	
Index	0x6066	
Subindex	0x00	
Data type	UNSIGNED16	
Access type	RW	
Default value	0	
Value range	0	0
PDO mapping	RXPDO	
Backup	NO	

6.2.97 Velocity demand value

Used as input for the position controller. For profiled moves, the value is generated by the profile generator. The value is given in [velocity units] (→page 2-16).

Name	Velocity demand value	
Index	0x606B	
Subindex	0x00	
Data type	INTEGER32	
Access type	RO	
Default value	-	
Value range	-	-
PDO mapping	TXPDO	
Backup	NO	

6.2.98 Velocity actual value

Provides the actual velocity value of the axis derived by the main sensor defined in →“Axis configuration” on page 6-132. If no main sensor is configured, the value is “0” (zero). The value is given in [velocity units] (→page 2-16).

Related objects: →“Velocity actual value averaged” on page 6-181 / →“Additional velocity actual values” on page 6-222

Name	Velocity actual value	
Index	0x606C	
Subindex	0x00	
Data type	INTEGER32	
Access type	RO	
Default value	-	
Value range	-	-
PDO mapping	TXPDO	
Backup	NO	

6.2.99 Target torque

Indicates the configured input value for the torque controller in Cyclic Synchronous Torque Mode. The value is given in per thousand of →“Motor rated torque” on page 6-206).

Related objects: →“Motor rated torque” on page 6-206

Name	Target torque	
Index	0x6071	
Subindex	0x00	
Data type	INTEGER16	
Access type	RW	
Default value	0	
Value range	–	–
PDO mapping	RXPDO	
Backup	NO	

6.2.100 Motor rated torque

Holds the value to which all torque objects are related to. The value is defined as «Nominal current» multiplied by the «Torque constant». The value is given in [μNm].

Changing the value by write access is not permitted.

Related objects: →“Motor data” on page 6-145

Name	Motor rated torque	
Index	0x6076	
Subindex	0x00	
Data type	UNSIGNED32	
Access type	RW	
Default value	0	
Value range	–	–
PDO mapping	NO	
Backup	NO	

6.2.101 Torque actual value

Provides the actual torque and corresponds to the motor’s instantaneous torque. The value is given in per thousand of →“Motor rated torque” on page 6-206).

Related objects: →“Motor rated torque” on page 6-206

Name	Torque actual value	
Index	0x6077	
Subindex	0x00	
Data type	INTEGER16	
Access type	RO	
Default value	–	
Value range	–	–
PDO mapping	TXPDO	
Backup	NO	

6.2.102 Target position

Used as input for the profile generator during profiled moves. Represents the position that the drive is supposed to move using the motion control parameters (such as velocity, acceleration, and deceleration). For non-profiled moves, the target position is directly used as input for the position controller. The value is given in [position units] (→page 2-16).

The target position is not set until the command is given by the →“Controlword” on page 6-199. In this case, the target position will be interpreted as absolute or relative depending on the command set to the controlword. Otherwise, the target position is interpreted as absolute value.

Related objects: →“Profile velocity” on page 6-211 / →“Profile acceleration” on page 6-211

Name	Target position	
Index	0x607A	
Subindex	0x00	
Data type	INTEGER32	
Access type	RW	
Default value	0	
Value range	–	–
PDO mapping	RXPDO	
Backup	NO	

6.2.103 Position range limit

Name	Position range limit
Index	0x607B
Object code	ARRAY
Highest subindex supported	2

6.2.103.1 Min position range limit

Defines the minimum position range limit by limiting the →Position demand value. Upon reaching or exceeding this limit, the input value automatically skips to the other end of the range. The value is given in [position units] (→page 2-16).

A value of “0” (zero) disables the minimum position range limit check.

Related objects: →“Position demand value” on page 6-204

Name	Min position range limit	
Index	0x607B	
Subindex	0x01	
Data type	INTEGER32	
Access type	RW	
Default value	0	
Value range	0	0
PDO mapping	RXPDO	
Backup	NO	

6.2.103.2 Max position range limit

Defines the maximum position range limit by limiting the →Position demand value. Upon reaching or exceeding this limit, the input value automatically skips to the other end of the range. The value is given in [position units] (→page 2-16).

A value of “0” (zero) disables the maximum position range limit check.

Related objects: →“Position demand value” on page 6-204

Name	Max position range limit	
Index	0x607B	
Subindex	0x02	
Data type	INTEGER32	
Access type	RW	
Default value	0	
Value range	0	0
PDO mapping	RXPDO	
Backup	YES	

6.2.104 Software position limit

Defines the min/max position values for the actual position value and the demand position value. An error is launched if the actual position value or the demand position value exceed their limits.

In PPM, the new target position is limited to the min/max position limit.

The software position limit supervision is inactive in Homing Mode (HMM).

Name	Software position limit
Index	0x607D
Object code	ARRAY
Highest subindex supported	2

6.2.104.1 Min position limit

Defines the absolute negative position limit for the →Position demand value or the →Position actual value. The value is given in [position units] (→page 2-16).

If the desired or the actual position is lower than the negative position limit, a software position limit error will be launched.

If the value of Min position limit and Max position limit is "0" (zero), the position limit check is disabled.

Related objects: →"Position demand value" on page 6-204 / →"Position actual value" on page 6-204

Name	Min position limit	
Index	0x607D	
Subindex	0x01	
Data type	INTEGER32	
Access type	RW	
Default value	0	
Value range	-2'147'483'648	2'147'483'647
PDO mapping	RXPDO	
Backup	YES	

6.2.104.2 Max position limit

Defines the absolute positive position limit for the →Position demand value or the →Position actual value. The value is given in [position units] (→page 2-16).

If the desired or the actual position is higher than the positive position limit, a software position limit error will be launched.

If the value of Min position limit and Max position limit is "0" (zero), position limit check is disabled.

Related objects: →"Position demand value" on page 6-204 / →"Position actual value" on page 6-204

Name	Max position limit	
Index	0x607D	
Subindex	0x02	
Data type	INTEGER32	
Access type	RW	
Default value	0	
Value range	-2'147'483'648	2'147'483'647
PDO mapping	RXPDO	
Backup	YES	

6.2.105 Max profile velocity

Used as velocity limit in a PPM or PVM move. The value is given in [velocity units] (→ page 2-16).

Related objects: →“Profile velocity” on page 6-211 / →“Homing speeds” on page 6-214 / →“Max motor speed” on page 6-210 / →“Target velocity” on page 6-227 / →“Max gear input speed” on page 6-150 / →“Axis configuration” on page 6-132 / →“Max system speed” on page 6-144

Name	Max profile velocity	
Index	0x607F	
Subindex	0x00	
Data type	UNSIGNED32	
Access type	RW	
Default value	50'000	
Value range	1	→Max system speed
PDO mapping	RXPDO	
Backup	YES	

6.2.106 Max motor speed

Indicates the configured maximal allowed speed for the motor. It serves as protection of the motor. The value is given in [rpm] (→ page 2-16).

For detailed motor specifications →maxon motor catalog.

Related objects: →“Motor type” on page 6-227 / →“Number of pole pairs” on page 6-146 / →“Max profile velocity” on page 6-210 / →“Target velocity” on page 6-227 / →“Max gear input speed” on page 6-150 / →“Max system speed” on page 6-144

Name	Max motor speed	
Index	0x6080	
Subindex	0x00	
Data type	UNSIGNED32	
Access type	RW	
Default value	50'000	
Value range	1	→Table 6-133
PDO mapping	RXPDO	
Backup	YES	

Motor type	Description	Maximum speed [rpm]
1	Brushed DC motor (maxon DC motor)	100'000
10	Brushless DC motor (maxon EC motor/BLDC motor), sinus commutated	50'000 / number of pole pairs
11	Brushless DC motor (maxon EC motor/BLDC motor), block commutated	100'000 / number of pole pairs

Table 6-133 Max motor speed

6.2.107 Profile velocity

Represents the velocity normally attained at the end of the acceleration ramp during a profiled move (PPM, PVM). The value is given in [velocity units] (→page 2-16).

Related objects: →“Max profile velocity” on page 6-210

Name	Profile velocity	
Index	0x6081	
Subindex	0x00	
Data type	UNSIGNED32	
Access type	RW	
Default value	1000	
Value range	1	→Max profile velocity
PDO mapping	RXPDO	
Backup	YES	

6.2.108 Profile acceleration

Defines the acceleration value used during a profiled move. The value is given in [acceleration units] (→page 2-16).

Name	Profile acceleration	
Index	0x6083	
Subindex	0x00	
Data type	UNSIGNED32	
Access type	RW	
Default value	10'000	
Value range	1	→Max acceleration
PDO mapping	RXPDO	
Backup	YES	

6.2.109 Profile deceleration

Defines the deceleration value used during a profiled move. The value is given in [acceleration units] (→page 2-16).

Name	Profile deceleration	
Index	0x6084	
Subindex	0x00	
Data type	UNSIGNED32	
Access type	RW	
Default value	10'000	
Value range	1	→Max acceleration
PDO mapping	RXPDO	
Backup	YES	

6.2.110 Quick stop deceleration

Used with a «Quick stop» command to determine the deceleration of the quick stop profile. The value is given in [acceleration units] (→page 2-16).

Related objects: →“Controlword” on page 6-199 / →“Fault reaction option code” on page 6-202 / →“Abort connection option code” on page 6-197

Name	Quick stop deceleration	
Index	0x6085	
Subindex	0x00	
Data type	UNSIGNED32	
Access type	RW	
Default value	10'000	
Value range	1	→Max acceleration
PDO mapping	RXPDO	
Backup	YES	

6.2.111 Motion profile type

Selects the type of motion profile trajectory used in →“Profile Position Mode (PPM)” on page 3-21, →“Homing Mode (HMM)” on page 3-28, or →“Profile Velocity Mode (PVM)” on page 3-25.

Name	Motion profile type	
Index	0x6086	
Subindex	0x00	
Data type	INTEGER16	
Access type	RW	
Default value	0	
Value range	→Table 6-134	–
PDO mapping	RXPDO	
Backup	YES	

Value	Description
0	linear ramp (trapezoidal profile)

Table 6-134 Motion profile types

6.2.112 Homing method

Used to select the desired homing method.

If the homing method is changed during an ongoing homing process, it will not come into effect before the next homing process is started.

Name	Homing method	
Index	0x6098	
Subindex	0x00	
Data type	INTEGER8	
Access type	RW	
Default value	7	
Value range	–	–
PDO mapping	RXPDO	
Backup	YES	

Value	Description
37	→Homing Method 37 (Actual Position)
34	→Homing Method 34 (Index Positive Speed)
33	→Homing Method 33 (Index Negative Speed)
27	→Homing Method 27 (Home Switch Negative Speed)
23	→Homing Method 23 (Home Switch Positive Speed)
18	→Homing Method 18 (Positive Limit Switch)
17	→Homing Method 17 (Negative Limit Switch)
11	→Homing Method 11 (Home Switch Negative Speed & Index)
7	→Homing Method 7 (Home Switch Positive Speed & Index)
2	→Homing Method 2 (Positive Limit Switch & Index)
1	→Homing Method 1 (Negative Limit Switch & Index)
-1	→Homing Method -1 (Current Threshold Positive Speed & Index)
-2	→Homing Method -2 (Current Threshold Negative Speed & Index)
-3	→Homing Method -3 (Current Threshold Positive Speed)
-4	→Homing Method -4 (Current Threshold Negative Speed)

Table 6-135 Homing methods

6.2.113 Homing speeds

Used to search a limit switch in a homing sequence. The value is given in [velocity units] (→page 2-16).

Related objects: →“Max profile velocity” on page 6-210

Name	Homing speeds
Index	0x6099
Object code	ARRAY
Highest subindex supported	2

6.2.113.1 Speed for switch search

Name	Speed for switch search	
Index	0x6099	
Subindex	0x01	
Data type	UNSIGNED32	
Access type	RW	
Default value	100	
Value range	1	→Max profile velocity
PDO mapping	RXPDO	
Backup	YES	

6.2.113.2 Speed for zero search

Used to search the index in a homing sequence. The value is given in [velocity units] (→page 2-16).

Name	Speed for zero search	
Index	0x6099	
Subindex	0x02	
Data type	UNSIGNED32	
Access type	RW	
Default value	10	
Value range	1	→Max profile velocity
PDO mapping	RXPDO	
Backup	YES	

6.2.114 Homing acceleration

Used to define acceleration and deceleration ramps in the homing profile. The value is given in [acceleration units] (→page 2-16).

Related objects: →“Max acceleration” on page 6-220

Name	Homing acceleration		
Index	0x609A		
Subindex	0x00		
Data type	UNSIGNED32		
Access type	RW		
Default value	1000		
Value range	1	→Max acceleration	
PDO mapping	RXPDO		
Backup	YES		

6.2.115 SI unit position

Defines the position units. Coding of the user-defined units and prefixes follows →chapter “2.3.1 SI Units” on page 2-16.

Write access is only permitted in device state «Power Disable».

Name	SI unit position		
Index	0x60A8		
Subindex	0x00		
Data type	UNSIGNED32		
Access type	RW		
Default value	0x00B50000		
Value range	→Table 6-137		
PDO mapping	NO		
Backup	YES		

Bit 31...24	Bit 23...16	Bit 15...8	Bit 7...0
Prefix	Numerator	Denominator	reserved (0)

Table 6-136 SI units position – Bits

Value	Description	Symbol
0x00B50000	Increments	inc

Table 6-137 SI units position – Value range

6.2.116 SI unit velocity

Defines the velocity units. Coding of the user-defined units and prefixes follows →chapter “2.3.1 SI Units” on page 2-16.

Write access is only permitted in device state «Power Disable».

Name	SI unit velocity
Index	0x60A9
Subindex	0x00
Data type	UNSIGNED32
Access type	RW
Default value	0x00B44700
Value range	→Table 6-139
PDO mapping	NO
Backup	YES

Bit 31...24	Bit 23...16	Bit 15...8	Bit 7...0
Prefix	Numerator	Denominator	reserved (0)

Table 6-138 SI units velocity – Bits

Value	Description	Symbol
0x00B44700	Revolutions/minute	rev/min (rpm)
0xFFB44700	0.1 revolutions/minute	deci rev/min (drpm)
0xFEB44700	0.01 revolutions/minute	centi rev/min (crpm)
0xFDB44700	0.001 revolutions/minute	milli rev/min (mrpm)
0xFCB44700	0.0001 revolutions/minute	10 ⁻⁴ rev/min (10 ⁻⁴ rpm)
0xFBB44700	0.00001 revolutions/minute	10 ⁻⁵ rev/min (10 ⁻⁵ rpm)
0xFAB44700	0.000001 revolutions/minute	micro rev/min (µrpm)

Table 6-139 SI units velocity – Value range

6.2.117 SI unit acceleration

Defines the acceleration units. Coding of the user-defined units and prefixes follows →chapter “2.3.1 SI Units” on page 2-16.

Write access is only permitted in device state «Power Disable».

Name	SI unit acceleration
Index	0x60AA
Subindex	0x00
Data type	UNSIGNED32
Access type	RW
Default value	0x00C00300
Value range	→Table 6-141
PDO mapping	NO
Backup	YES

Bit 31...24	Bit 23...16	Bit 15...8	Bit 7...0
Prefix	Numerator	Denominator	reserved (0)

Table 6-140 SI units acceleration – Bits

Value	Description	Symbol
0x00C00300	(Revolutions/minute)/second	rpm/s

Table 6-141 SI units acceleration – Value range

6.2.118 Position offset

Provides the offset of the position. The value is given in [increments].

- In CSP, the object contains the commanded additive position of the drive which is then added to the →Target position.

Related objects: →“Target position” on page 6-207

Name	Position offset
Index	0x60B0
Subindex	0x00
Data type	INTEGER32
Access type	RW
Default value	0
Value range	– –
PDO mapping	RXPDO
Backup	NO

6.2.119 Velocity offset

In CSV, the object provides the offset towards the →Target velocity. The value itself is absolute but, since it represents an additive velocity value, it also can be used to control the drive with relative values in respect to the →Target velocity. The value is given in [velocity units] (→page 2-16).

Name	Velocity offset	
Index	0x60B1	
Subindex	0x00	
Data type	INTEGER32	
Access type	RW	
Default value	0	
Value range	–	–
PDO mapping	RXPDO	
Backup	NO	

6.2.120 Torque offset

Provides the offset of the torque. The value is given in per thousand of →“Motor rated torque” on page 6-206.

- In CSP, the object contains the input value for torque feed forward.
- In CST, the object contains the commanded additive torque of the drive which is then added to the →Target torque.

Related objects: →“Target torque” on page 6-206

Name	Torque offset	
Index	0x60B2	
Subindex	0x00	
Data type	INTEGER16	
Access type	RW	
Default value	0	
Value range	–	–
PDO mapping	RXPDO	
Backup	NO	

6.2.121 Interpolation time period

Name	Interpolation time period
Index	0x60C2
Object code	RECORD
Highest subindex supported	2

6.2.121.1 Interpolation time period value

Indicates the time between two PDOs. Values > "0" (zero) enable the demand value interpolation in CSP and CSV. It is of importance that the setpoint (→Target position, →Position offset, →Target velocity, →Velocity offset) is written cyclically with the interpolation time period.

The value is given in [$s \cdot 10^{\text{interpolation time index}}$]. An →Interpolation time index of value -3 indicates that the interpolation time period value is given in milliseconds.

The value "0" (zero) disables the demand value interpolation.

Name	Interpolation time period value	
Index	0x60C2	
Subindex	0x01	
Data type	UNSIGNED8	
Access type	RW	
Default value	0	
Value range	0	100
PDO mapping	YES	
Backup	YES	

6.2.121.2 Interpolation time index

Defines the unit of the →Interpolation time period value. The value -3 corresponds to the unit [ms].

Name	Interpolation time index	
Index	0x60C2	
Subindex	0x02	
Data type	INTEGER8	
Access type	RW	
Default value	-3	
Value range	-3	-3
PDO mapping	YES	
Backup	YES	

6.2.122 *Max acceleration*

Used to limit the maximal allowed acceleration to prevent mechanical damage. It represents the limit of all other acceleration/deceleration objects of the axis. The value is given in [acceleration units] (→page 2-16). In cyclic modes (CSP, CSV, CST), the object is not taken into account.

Related objects: →“Profile acceleration” on page 6-211 / →“Profile deceleration” on page 6-211 / →“Quick stop deceleration” on page 6-212 / →“Homing acceleration” on page 6-215

Name	Max acceleration	
Index	0x60C5	
Subindex	0x00	
Data type	UNSIGNED32	
Access type	RW	
Default value	4'294'967'295	
Value range	1	4'294'967'295
PDO mapping	RXPDO	
Backup	YES	

6.2.123 Additional position actual values

Provides the actual position values of the axis derived by the sensors defined in →“Axis configuration” on page 6-132. If no sensor is configured in the corresponding field, the position actual value is “0” (zero). The value is given in [position units] (→page 2-16).

Related objects: →“Position actual value” on page 6-204

Name	Additional position actual values
Index	0x60E4
Object code	ARRAY
Highest subindex supported	3

6.2.123.1 Position actual value sensor 1

Name	Position actual value sensor 1	
Index	0x60E4	
Subindex	0x01	
Data type	INTEGER32	
Access type	RO	
Default value	–	
Value range	–	–
PDO mapping	TXPDO	
Backup	NO	

6.2.123.2 Position actual value sensor 2

Name	Position actual value sensor 2	
Index	0x60E4	
Subindex	0x02	
Data type	INTEGER32	
Access type	RO	
Default value	–	
Value range	–	–
PDO mapping	TXPDO	
Backup	NO	

6.2.123.3 Position actual value sensor 3

Name	Position actual value sensor 3	
Index	0x60E4	
Subindex	0x03	
Data type	INTEGER32	
Access type	RO	
Default value	–	
Value range	–	–
PDO mapping	TXPDO	
Backup	NO	

6.2.124 Additional velocity actual values

Provides the actual velocity values of the axis derived by the sensors defined in →“Axis configuration” on page 6-132. If no sensor is configured in the corresponding field, the velocity actual value is “0” (zero). The value is given in [velocity units] (→page 2-16).

The averaged velocity values represent the corresponding velocity actual value filtered by 1st order digital low-pass filter with a cut-off frequency of 5 Hz.

Related objects: →“Velocity actual value” on page 6-205 / →“Velocity actual value averaged” on page 6-181

Name	Additional velocity actual values
Index	0x60E5
Object code	ARRAY
Highest subindex supported	11

6.2.124.1 Velocity actual value sensor 1

Name	Velocity actual value sensor 1	
Index	0x60E5	
Subindex	0x01	
Data type	INTEGER32	
Access type	RO	
Default value	–	
Value range	–	–
PDO mapping	TXPDO	
Backup	NO	

6.2.124.2 Velocity actual value sensor 2

Name	Velocity actual value sensor 2	
Index	0x60E5	
Subindex	0x02	
Data type	INTEGER32	
Access type	RO	
Default value	–	
Value range	–	–
PDO mapping	TXPDO	
Backup	NO	

6.2.124.3 Velocity actual value sensor 3

Name	Velocity actual value sensor 3	
Index	0x60E5	
Subindex	0x03	
Data type	INTEGER32	
Access type	RO	
Default value	-	
Value range	-	-
PDO mapping	TXPDO	
Backup	NO	

6.2.124.4 Velocity actual value averaged sensor 1

Name	Velocity actual value averaged sensor 1	
Index	0x60E5	
Subindex	0x09	
Data type	INTEGER32	
Access type	RO	
Default value	-	
Value range	-	-
PDO mapping	TXPDO	
Backup	NO	

6.2.124.5 Velocity actual value averaged sensor 2

Name	Velocity actual value averaged sensor 2	
Index	0x60E5	
Subindex	0x0A	
Data type	INTEGER32	
Access type	RO	
Default value	-	
Value range	-	-
PDO mapping	TXPDO	
Backup	NO	

6.2.124.6 Velocity actual value averaged sensor 3

Name	Velocity actual value averaged sensor 3	
Index	0x60E5	
Subindex	0x0B	
Data type	INTEGER32	
Access type	RO	
Default value	-	
Value range	-	-
PDO mapping	TXPDO	
Backup	NO	

6.2.125 Following error actual value

Represents the actual value of the following error. The value is given in [position units] (→ page 2-16).

Name	Following error actual value	
Index	0x60F4	
Subindex	0x00	
Data type	INTEGER32	
Access type	RO	
Default value	–	
Value range	–	–
PDO mapping	TXPDO	
Backup	NO	

6.2.126 Digital inputs

Displays the state of the digital input functionalities (after polarity correction by →“Digital input properties” on page 6-184; Polarity). A bit is read as “1” if the signal at the corresponding pin is high.

Related objects: →“Digital input properties” on page 6-184 / →“Configuration of digital inputs” on page 6-185

Name	Digital inputs	
Index	0x60FD	
Subindex	0x00	
Data type	UNSIGNED32	
Access type	RO	
Default value	–	
Value range	–	–
PDO mapping	TXPDO	
Backup	NO	

Bit	Functionality	Description
31...29	reserved	–
28	Quick stop	Stop movement and switch to «Quick stop active» state (→“Device Control” on page 2-13 for valid transitions)
27	Drive enable	Enable/disable the drive or clear errors in «Fault» state (→“Device Control” on page 2-13 for valid transitions)
26	reserved	–
25	Positive limit switch without errors	Used in some homing modes / does not generate limit errors
24	Negative limit switch without errors	Used in some homing modes / does not generate limit errors
23	General purpose H	State can be read
22	General purpose G	State can be read
21	General purpose F	State can be read
20	General purpose E	State can be read
19	General purpose D	State can be read
18	General purpose C	State can be read
17	General purpose B	State can be read
16	General purpose A	State can be read
15...3	reserved	–
2	Home switch	Used in some homing modes
1	Positive limit switch	Used in some homing modes / generates limit error
0	Negative limit switch	Used in some homing modes / generates limit error

Table 6-142 Digital inputs

6.2.127 Digital outputs

Configures the state of the digital output functionalities (before polarity correction by →“Digital output properties” on page 6-187; Polarity). If a bit is set to “1” and the polarity bit is set to “0” (zero), the signal at the corresponding pin is high.

Related objects: →“Digital output properties” on page 6-187 / →“Configuration of digital outputs” on page 6-188

Name	Digital outputs
Index	0x60FE
Object code	ARRAY
Highest subindex supported	1

6.2.127.1 Physical outputs

Name	Physical outputs	
Index	0x60FE	
Subindex	0x01	
Data type	UNSIGNED32	
Access type	Bit 0...23: RW / Bit 24...31: RO	
Default value	0	
Value range	–	–
PDO mapping	RXPDO	
Backup	NO	

Bit	Functionality	Description
31...26	reserved	–
25	Ready/Fault	Active on device ready / inactive on device fault state
24	Holding brake	Output functionality to drive a holding brake (for details →“Holding brake parameters” on page 6-189)
23...19	reserved	–
18	General purpose C	State can be read/written by the host
17	General purpose B	State can be read/written by the host
16	General purpose A	State can be read/written by the host
15...1	reserved	–
0	Set brake (GPIO)	–

Table 6-143 Digital outputs

6.2.128 Target velocity

In Profile Velocity Mode (PVM), the object indicates the configured target velocity and is used as input for the trajectory generator. The value is given in [velocity units] (→page 2-16).

Related objects: →“Max profile velocity” on page 6-210 / →“Max motor speed” on page 6-210 / →“Profile acceleration” on page 6-211 / →“Profile deceleration” on page 6-211

Name	Target velocity	
Index	0x60FF	
Subindex	0x00	
Data type	INTEGER32	
Access type	RW	
Default value	0	
Value range	–	–
PDO mapping	RXPDO	
Backup	NO	

6.2.129 Motor type

Defines the motor type of the axis.

Changes are only supported in device state «Power Disable».

Related objects: →“Axis configuration” on page 6-132 / →“Motor data” on page 6-145

Name	Motor type	
Index	0x6402	
Subindex	0x00	
Data type	UNSIGNED16	
Access type	RW	
Default value	10	
Value range	→Table 6-144	
PDO mapping	NO	
Backup	YES	

Value	DS-402 Name	Description
1	Phase-modulated DC motor	Brushed DC motor (maxon DC motor)
10	Sinusoidal PM BL motor	Brushless DC motor BLDC sinus commutated (maxon EC motor)
11	Trapezoidal PM BL motor	Brushless DC motor BLDC block commutated (maxon EC motor)

Table 6-144 Motor types

6.2.130 Supported drive modes

Provides an overview of the implemented operating modes in the device. Supported are the following modes:

- → Profile Position Mode (PPM)
- → Profile Velocity Mode (PVM)
- → Homing Mode (HMM)
- → Cyclic Synchronous Position Mode (CSP)
- → Cyclic Synchronous Velocity Mode (CSV)
- → Cyclic Synchronous Torque Mode (CST)

Name	Supported drive modes	
Index	0x6502	
Subindex	0x00	
Data type	UNSIGNED32	
Access type	RO	
Default value	0x000003A5	
Value range	–	–
PDO mapping	TXPDO	
Backup	NO	

Bit		Description
31...11	0	reserved
10	0	Cyclic Synchronous Torque Mode With Commutation Angle
9	1	Cyclic Synchronous Torque Mode (CST)
8	1	Cyclic Synchronous Velocity Mode (CSV)
7	1	Cyclic Synchronous Position Mode (CSP)
6	0	Interpolated Position Mode (IPM)
5	1	Homing Mode (HMM)
4	0	reserved
3	0	Torque Mode
2	1	Profile Velocity Mode (PVM)
1	0	Velocity Mode
0	1	Profile Position Mode (PPM)

Table 6-145 Supported drive modes – Bits

6.2.131 Modular device profile**The object is only available if the active fieldbus is EtherCAT.**

Contains the information to interpret the objects in function areas of the modules.

Name	Modular device profile
Index	0xF000
Object code	RECORD
Highest subindex supported	2

6.2.131.1 Index distance

Name	Index distance	
Index	0xF000	
Subindex	0x01	
Data type	UNSIGNED16	
Access type	RO	
Default value	–	
Value range	0x0010	0x0010
PDO mapping	NO	
Backup	NO	

6.2.131.2 Maximum number of modules

Name	Maximum number of modules	
Index	0xF000	
Subindex	0x02	
Data type	UNSIGNED16	
Access type	RO	
Default value	–	
Value range	1	1
PDO mapping	NO	
Backup	NO	

6.2.132 Configured module ident list



The object is only available if the active fieldbus is EtherCAT.

Contains the identification numbers of the configured modules.

The device supports only one module. If the number of configured modules is set to "0" (zero), no module is active.

Write access is only permitted in ESM state «Pre-Operational».

Name	Configured module ident list
Index	0xF030
Object code	ARRAY
Highest subindex supported	1

6.2.132.1 Nbr of configured modules

Name	Nbr of configured modules	
Index	0xF030	
Subindex	0x00	
Data type	UNSIGNED8	
Access type	RW	
Default value	0	
Value range	0	1
PDO mapping	NO	
Backup	NO	

6.2.132.2 Module 1

For details and their definitions on objects specified for the MDP modules →chapter “6.3 Modular Device Profile Module” on page 6-233.

Name	Module 1
Index	0xF030
Subindex	0x01
Data type	UNSIGNED32
Access type	RW
Default value	–
Value range	→Table 6-147
PDO mapping	NO
Backup	NO

Bit 31...28 (Nibble)	Bit 27...24 (Nibble)	Bit 23...8 (Word)	Bit 7...0 (Byte)
(0x6) EPOS4	Op mode	Application number	Version

Table 6-146 Configured module identification – Bits

Value	Description (MDP Profile 742)
0x61xxxxxx	PPM module ident
0x63xxxxxx	PVM module ident
0x68xxxxxx	CSP module ident
0x69xxxxxx	CSV module ident
0x6Axxxxxx	CST module ident

Table 6-147 Configured module identification types

6.2.133 Detected module ident list



The object is only available if the active fieldbus is EtherCAT.

Contains the module identification during power-up or after executing the «Detect Modules Command».

Name	Detected module ident list	
Index	0xF050	
Object code	ARRAY	
Highest subindex supported	1	

6.2.133.1 Nbr of detected modules

Name	Nbr of detected modules	
Index	0xF050	
Subindex	0x00	
Data type	UNSIGNED8	
Access type	RO	
Default value	0	
Value range	0	1
PDO mapping	NO	
Backup	NO	

6.2.133.2 Module 1

Name	Module 1	
Index	0xF050	
Subindex	0x01	
Data type	UNSIGNED32	
Access type	RO	
Default value	–	
Value range	→Table 6-147	
PDO mapping	NO	
Backup	NO	

6.3 Modular Device Profile Module

In the EtherCAT Slave Information (ESI) file, the default PDO mapping for the different operation modes is defined as Modular Device Profile (MDP) module. The module can be used by the EtherCAT master to remap the PDO for the selected mode.

The module outputs are assigned to the Receive PDO1 mapping (1600-xx), the module inputs are assigned to the Transmit PDO1 mapping (1A00-xx).

Related objects: →“Modular device profile” on page 6-229 / →“Configured module ident list” on page 6-230 / →“Detected module ident list” on page 6-232

6.3.1 MDP Module PPM

Mapped object	Object (index-subindex)	Object name
1 st	0x6040-00	→Controlword
2 nd	0x607A-00	→Target position
3 rd	0x6083-00	→Profile acceleration
4 th	0x6084-00	→Profile deceleration
5 th	0x6081-00	→Profile velocity
6 th	0x6060-00	→Modes of operation
7 th	0x60FE-01	→Digital outputs

Table 6-148 MDP module PPM mapping – Default values for RxPDO

Mapped object	Object (index-subindex)	Object name
1 st	0x6041-00	→Statusword
2 nd	0x6064-00	→Position actual value
3 rd	0x606C-00	→Velocity actual value
4 th	0x60F4-00	→Following error actual value
5 th	0x6061-00	→Modes of operation display
6 th	0x60FD-00	→Digital inputs

Table 6-149 MDP module PPM mapping – Default values for TxPDO

6.3.2 MDP Module PVM

Mapped object	Object (index-subindex)	Object name
1 st	0x6040-00	→Controlword
2 nd	0x60FF-00	→Target velocity
3 rd	0x6083-00	→Profile acceleration
4 th	0x6084-00	→Profile deceleration
5 th	0x6060-00	→Modes of operation
6 th	0x60FE-01	→Digital outputs

Table 6-150 MDP module PVM mapping – Default values for RxPDO

Mapped object	Object (index-subindex)	Object name
1 st	0x6041-00	→ Statusword
2 nd	0x6064-00	→ Position actual value
3 rd	0x606C-00	→ Velocity actual value
4 th	0x6061-00	→ Modes of operation display
5 th	0x60FD-00	→ Digital inputs

Table 6-151 MDP module PVM mapping – Default values for TxPDO

6.3.3 MDP Module CSP

Mapped object	Object (index-subindex)	Object name
1 st	0x6040-00	→ Controlword
2 nd	0x607A-00	→ Target position
3 rd	0x60B0-00	→ Position offset
4 th	0x60B2-00	→ Torque offset
5 th	0x6060-00	→ Modes of operation
6 th	0x60FE-01	→ Digital outputs

Table 6-152 MDP module CSP mapping – Default values for RxPDO

Mapped object	Object (index-subindex)	Object name
1 st	0x6041-00	→ Statusword
2 nd	0x6064-00	→ Position actual value
3 rd	0x606C-00	→ Velocity actual value
4 th	0x6077-00	→ Torque actual value
5 th	0x6061-00	→ Modes of operation display
6 th	0x60FD-00	→ Digital inputs

Table 6-153 MDP module CSP mapping – Default values for TxPDO

6.3.4 MDP Module CSV

Mapped object	Object (index-subindex)	Object name
1 st	0x6040-00	→ Controlword
2 nd	0x60FF-00	→ Target velocity
3 rd	0x60B1-00	→ Velocity offset
4 th	0x6060-00	→ Modes of operation
5 th	0x60FE-01	→ Digital outputs

Table 6-154 MDP module CSV mapping – Default values for RxPDO

Mapped object	Object (index-subindex)	Object name
1 st	0x6041-00	→ Statusword
2 nd	0x6064-00	→ Position actual value
3 rd	0x606C-00	→ Velocity actual value
4 th	0x6077-00	→ Torque actual value
5 th	0x6061-00	→ Modes of operation display
6 th	0x60FD-00	→ Digital inputs

Table 6-155 MDP module CSV mapping – Default values for TxPDO

6.3.5 MDP Module CST

Mapped object	Object (index-subindex)	Object name
1 st	0x6040-00	→ Controlword
2 nd	0x6071-00	→ Target torque
3 rd	0x60B2-00	→ Torque offset
4 th	0x6060-00	→ Modes of operation
5 th	0x60FE-01	→ Digital outputs

Table 6-156 MDP module CST mapping – Default values for RxPDO

Mapped object	Object (index-subindex)	Object name
1 st	0x6041-00	→ Statusword
2 nd	0x6064-00	→ Position actual value
3 rd	0x606C-00	→ Velocity actual value
4 th	0x6077-00	→ Torque actual value
5 th	0x6061-00	→ Modes of operation display
6 th	0x60FD-00	→ Digital inputs

Table 6-157 MDP module CST mapping – Default values for TxPDO

••page intentionally left blank••

7 Error Handling

7.1 Emergency Message Frame

Upon detection of device-internal errors, the device will transmit emergency message frames over the CANopen network using →“COB-ID EMCY” on page 6-71. An emergency message frame will be transmitted only once per error event and consists of the error code and the actual state of the →“Error register” on page 6-66.

Byte	0	1	2	3	4	5	6	7
Description	Error code		Error register	Not used (always “0”)				

Table 7-158 Emergency message frame

7.2 Device Errors

An EPOS4 can detect a variety of device errors. The reaction to an error depends on error type and option code. After execution of the fault reaction, the device changes to fault state and the drive will be disabled.

The →“Error history” on page 6-67 holds the error codes that occurred and will be signaled via an emergency message frames. The →“Error register” on page 6-66 holds all set error flags and provides a summary on possible errors.

For fault reaction codes, the following notations will be used:

- a: Use →“Abort connection option code” on page 6-197.
- f: Use →“Fault reaction option code” on page 6-202.
- d: A secure movement is no longer possible.

“Position Clear” points out that the position will be clearing upon executing the error reset.

Error code	Error register	Name	Fault reaction code	Position clear
0x0000	0000 0000b	No Error	–	
0x1000	0000 0001b	→Generic error	d	
0x1080 ... 0x1083	0000 0001b	→Generic initialization error	d	
0x1090	0000 0001b	→Firmware incompatibility error	d	
0x2310	0000 0010b	→Overcurrent error	d	
0x2320	0000 0010b	→Power stage protection error	d	
0x3210	0000 0100b	→Overvoltage error	d	
0x3220	0000 0100b	→Undervoltage error	d	
0x4210	0000 1000b	→Thermal overload error	d	
0x4380	0000 1000b	→Thermal motor overload error	d	
0x5113	0000 0100b	→Logic supply voltage too low error	d	
0x5280	0000 0001b	→Hardware defect error	d	
0x5281	0000 0001b	→Hardware incompatibility error	d	

Continued on next page.

Error code	Error register	Name	Fault reaction code	Position clear
0x5480 ... 0x5483	0000 0001b	→Hardware error	d	
0x6080	0000 0001b	→Sign of life error	d	
0x6081	0000 0001b	→Extension 1 watchdog error	a	
0x6180 ... 0x6190	0000 0001b	→Internal software error	d	
0x6320	0000 0001b	→Software parameter error	f	
0x6380	0000 0001b	→Persistent parameter corrupt error	d	
0x7320	0010 0000b	→Position sensor error	d	
0x7380	0010 0000b	→Position sensor breach error	d	X
0x7381	0010 0000b	→Position sensor resolution error	d	X
0x7382	0010 0000b	→Position sensor index error	d	X
0x7388	0010 0000b	→Hall sensor error	d	X
0x7389	0010 0000b	→Hall sensor not found error	d	X
0x738A	0010 0000b	→Hall angle detection error	d	X
0x738C	0010 0000b	→SSI sensor error	d	
0x7390	0010 0000b	→Missing main sensor error	d	
0x7391	0010 0000b	→Missing commutation sensor error	d	
0x7392	0010 0000b	→Main sensor direction error	d	X
0x8110	0001 0000b	→CAN overrun error (object lost)	a	
0x8111	0001 0000b	→CAN overrun error	a	
0x8120	0001 0000b	→CAN passive mode error	a	
0x8130	0001 0000b	→CAN heartbeat error	a	
0x8150	0001 0000b	→CAN PDO COB-ID collision	a	
0x8180	0001 0000b	→EtherCAT communication error	a	
0x8181	0001 0000b	→EtherCAT initialization error	d	
0x8182	0001 0000b	→EtherCAT Rx queue overflow	a	
0x8183	0001 0000b	→EtherCAT communication error (internal)	a	
0x81FD	0001 0000b	→CAN bus turned off	a	
0x81FE	0001 0000b	→CAN Rx queue overflow	a	
0x81FF	0001 0000b	→CAN Tx queue overflow	a	
0x8210	0001 0000b	→CAN PDO length error	a	
0x8250	0001 0000b	→RPDO timeout	a	
0x8280	0001 0000b	→EtherCAT PDO communication error	a	
0x8281	0001 0000b	→EtherCAT SDO communication error	a	
0x8611	1000 0000b	→Following error	f	
0x8A80	1000 0000b	→Negative limit switch error	f	

Continued on next page.

Error code	Error register	Name	Fault reaction code	Position clear
0x8A81	1000 0000b	→Positive limit switch error	f	
0x8A82	1000 0000b	→Software position limit error	f	
0x8A88	0000 0001b	→STO error	d	
0xFF01	0000 0001b	→System overloaded error	d	
0xFF02	0000 0001b	→Watchdog error	d	X
0xFF0B	0000 0001b	→System peak overloaded error	d	
0xFF10	0010 0000b	→Controller gain error	f	
0xFF12	0010 0000b	→Auto tuning current limit error	d	
0xFF13	0010 0000b	→Auto tuning identification current error	d	
0xFF14	0010 0000b	→Auto tuning data sampling error	d	
0xFF15	0010 0000b	→Auto tuning sample mismatch error	d	
0xFF16	0010 0000b	→Auto tuning parameter error	d	
0xFF17	0010 0000b	→Auto tuning amplitude mismatch error	d	
0xFF18	0010 0000b	→Auto tuning period length error	d	
0xFF19	0010 0000b	→Auto tuning timeout error	d	
0xFF20	0010 0000b	→Auto tuning standstill error	d	
0xFF21	0010 0000b	→Auto tuning torque invalid error	d	

Table 7-159 Device error codes

7.2.1 Generic error

Error code	0x1000
Error register	0000 0001b
Cause	Unspecific error occurred
Effect	Device disabled Red LED "ON" Error flag set in →Statusword
Error recovery	Reset fault with →Controlword

7.2.2 Generic initialization error

Error code	0x1080 thru 0x1083
Error register	0000 0001b
Cause	Critical error occurred during boot-up
Effect	Device disabled Red LED "ON" Error flag set in →Statusword
Error recovery	Reset device. If the problem persists, contact your supplier.

7.2.3 Firmware incompatibility error

Error code	0x1090
Error register	0000 0001b
Cause	Incompatible extension firmware version detected
Effect	Device disabled Red LED "ON" Error flag set in → Statusword
Error recovery	First, try to resolve by resetting the device. If reset fails, update the EPOS4 firmware with the extension attached. If the problem persists, contact your supplier.

7.2.4 Overcurrent error

Error code	0x2310
Error register	0000 0010b
Cause	Short circuit in motor winding. Controller gains too high and/or deceleration too high. Damaged power stage.
Effect	Device disabled Red LED "ON" Error flag set in → Statusword
Error recovery	Reset fault with → Controlword

7.2.5 Power stage protection error

Error code	0x2320
Error register	0000 0010b
Cause	Short circuit of motor winding against ground. Short circuit of motor winding against operating voltage Vcc. Damaged power stage.
Effect	Device disabled Red LED "ON" Error flag set in → Statusword
Error recovery	Reset fault with → Controlword

7.2.6 Overvoltage error

Error code	0x3210
Error register	0000 0100b
Cause	Power supply voltage too high
Effect	Device disabled Red LED "ON" Error flag set in → Statusword
Error recovery	In most cases this error occurs at deceleration where the motor works as a generator and the energy flows from motor to power supply (resulting in an increased voltage). Usually, a capacitor (for example 2200 µF) close to the device will solve the problem. If not, a shunt regulator will be necessary to dissipate brake energy. Reset fault with → Controlword (only possible if supply voltage is in valid range).

7.2.7 Undervoltage error

Error code	0x3220
Error register	0000 0100b
Cause	Supply voltage is too low for operation. Power supply cannot supply required acceleration current.
Effect	Device disabled Red LED "ON" Error flag set in → Statusword
Error recovery	Reset fault with → Controlword

7.2.8 Thermal overload error

Error code	0x4210
Error register	0000 1000b
Cause	Temperature at device's power stage too high
Effect	Device disabled Red LED "ON" Error flag set in → Statusword
Error recovery	Reset fault with → Controlword (only possible if temperature is in valid range)

7.2.9 Thermal motor overload error

Error code	0x4380
Error register	0000 1000b
Cause	Temperature at motor too high or sensor not connected
Effect	Device disabled Red LED "ON" Error flag set in → Statusword
Error recovery	Reset fault with → Controlword (only possible if temperature is in valid range)

7.2.10 Logic supply voltage too low error

Error code	0x5113
Error register	0000 0100b
Cause	Logic supply voltage is too low for operation
Effect	Device disabled Red LED "ON" Error flag set in → Statusword
Error recovery	Reset fault with → Controlword (only possible if supply voltage is in valid range)

7.2.11 Hardware defect error

Error code	0x5280
Error register	0000 1000b
Cause	Hardware problem detected
Effect	Device disabled Red LED "ON" Error flag set in → Statusword
Error recovery	Reset device. If the problem persists, contact your supplier.

7.2.12 Hardware incompatibility error

Error code	0x5281
Error register	0000 1000b
Cause	An incompatible hardware combination was detected
Effect	Device disabled Red LED "ON" Error flag set in → Statusword
Error recovery	Reset device. If the problem persists, contact your supplier.

7.2.13 Hardware error

Error code	0x5480 thru 0x5483
Error register	0000 0001b
Cause	A hardware problem was detected
Effect	Device disabled Red LED "ON" Error flag set in → Statusword
Error recovery	Reset device. If the problem persists, contact your supplier.

7.2.14 Sign of life error

Error code	0x6080
Error register	0000 0001b
Cause	Problem with connection to extension 1: <ul style="list-style-type: none"> • Overload situation • Extension hardware failure
Effect	Device disabled Red LED "ON" Error flag set in → Statusword
Error recovery	Reset fault with → Controlword Check that extension 1 is firmly connected If problem reoccurs frequently: <ul style="list-style-type: none"> • Update firmware • Contact your supplier

7.2.15 Extension 1 watchdog error

Error code	0x6081
Error register	0000 0001b
Cause	Connection loss to extension 1: <ul style="list-style-type: none"> • Overload situation • Extension hardware failure
Effect	Device disabled Red LED "ON" Error flag set in → Statusword
Error recovery	Reset fault with → Controlword Check that extension 1 is firmly connected If problem reoccurs frequently: <ul style="list-style-type: none"> • Update firmware • Contact your supplier

7.2.16 Internal software error

Error code	0x6180 thru 0x6190
Error register	0010 0000b
Cause	An internal software error occurred
Effect	Device disabled Red LED "ON" Error flag set in → Statusword
Error recovery	Reset fault with → Controlword

7.2.17 Software parameter error

Error code	0x6320
Error register	0010 0000b
Cause	Corrupt parameter detected
Effect	Fault reaction defined in → Fault reaction option code
Error recovery	Reset fault with → Controlword

7.2.18 Persistent parameter corrupt error

Error code	0x6380
Error register	0000 0001b
Cause	Persistent parameters are corrupt or inconsistent (wrong CRC)
Effect	Default parameters are set Device disabled Red LED "ON" Error flag set in → Statusword
Error recovery	Reset fault with → Controlword Set or load device parameters again

7.2.19 Position sensor error

Error code	0x7320
Error register	0010 0000b
Cause	Detected position of position sensor is no longer valid due to... <ul style="list-style-type: none"> • changed/wrong position sensor parameters • other errors that influence the absolute position detection (such as Hall Sensor Error, Position Sensor Index Error, etc.)
Effect	Device disabled Red LED "ON" Error flag set in → Statusword
Error recovery	Reset fault with → Controlword

7.2.20 Position sensor breach error

Error code	0x7380
Error register	0010 0000b
Cause	Position sensor supervision has detected a bad working condition due to... <ul style="list-style-type: none"> • wrong/broken wiring of encoder • defective encoder • regulation parameter are not well tuned (→ Current control parameter set)
Effect	Device disabled Red LED "ON" Error flag set in → Statusword
Error recovery	Reset fault with → Controlword

7.2.21 Position sensor resolution error

Error code	0x7381
Error register	0010 0000b
Cause	Encoder pulses counted between the first two index pulses do not fit the resolution. Setting of encoder resolution is wrong.
Effect	Device disabled Red LED "ON" Error flag set in → Statusword
Error recovery	Reset fault with → Controlword

7.2.22 Position sensor index error

Error code	0x7382
Error register	0010 0000b
Cause	Encoder index signal was not found within two turns at start-up due to... <ul style="list-style-type: none"> • incorrect wiring of encoder cables • encoder without or with defective index channel • wrong sensor type • setting for encoder resolution too low
Effect	Device disabled Red LED "ON" Error flag set in → Statusword
Error recovery	Reset fault with → Controlword

7.2.23 Hall sensor error

Error code	0x7388
Error register	0010 0000b
Cause	Motor Hall sensors report an impossible signal combination due to... <ul style="list-style-type: none"> • incorrect wiring of Hall sensors • incorrect wiring of Hall sensor supply voltage • damaged Hall sensors • big Hall sensor signal noise
Effect	Device disabled Red LED "ON" Error flag set in → Statusword
Error recovery	Reset fault with → Controlword

7.2.24 Hall sensor not found error

Error code	0x7389
Error register	0010 0000b
Cause	No Hall sensor 3 edge found within first motor turn due to... <ul style="list-style-type: none"> • wrong wiring of Hall sensors • defective Hall sensors • setting for encoder resolution too low
Effect	Device disabled Red LED "ON" Error flag set in → Statusword
Error recovery	Reset fault with → Controlword

7.2.25 Hall angle detection error

Error code	0x738A
Error register	0010 0000b
Cause	Angle difference measured between encoder and Hall sensors is too high due to... <ul style="list-style-type: none"> • wrong wiring of Hall sensors • defective Hall sensors • wrong wiring of encoder • defective encoder • wrong setting of encoder resolution or pole pairs
Effect	Device disabled Red LED "ON" Error flag set in → Statusword
Error recovery	Reset fault with → Controlword

7.2.26 SSI sensor error

Error code	0x738C
Error register	0010 0000b
Cause	SSI sensor driver could not sample position data
Effect	Device disabled Red LED "ON" Error flag set in → Statusword
Error recovery	Reset fault with → Controlword

7.2.27 Missing main sensor error

Error code	0x7390
Error register	0010 0000b
Cause	No main sensor available. Adapt settings in →Axis configuration.
Effect	Device disabled Red LED "ON" Error flag set in →Statusword
Error recovery	Reset fault with →Controlword

7.2.28 Missing commutation sensor error

Error code	0x7391
Error register	0010 0000b
Cause	No commutation sensor available. Adapt settings in →Axis configuration.
Effect	Device disabled Red LED "ON" Error flag set in →Statusword
Error recovery	Reset fault with →Controlword

7.2.29 Main sensor direction error

Error code	0x7392
Error register	0010 0000b
Cause	Position sensor supervision has detected a turn-away of the motor in the opposite direction due to... <ul style="list-style-type: none"> • wrong setting of sensor polarity, • wrong position sensor wiring, or • wrong motor wiring.
Effect	Device disabled Red LED "ON" Error flag set in →Statusword
Error recovery	Reset fault with →Controlword

7.2.30 CAN overrun error (object lost)

Error code	0x8110
Error register	0001 0000b
Cause	One of the CAN mail boxes experienced an overflow caused by too high communication rate
Effect	Fault reaction defined in →Abort connection option code
Error recovery	Reset fault with →Controlword

7.2.31 CAN overrun error

Error code	0x8111
Error register	0001 0000b
Cause	Execution of CAN communication had an overrun caused by too high communication rate
Effect	Fault reaction defined in →Abort connection option code
Error recovery	Reset fault with →Controlword

7.2.32 CAN passive mode error

Error code	0x8120
Error register	0001 0000b
Cause	Device changed to CAN passive mode due to... <ul style="list-style-type: none"> • CAN bit rate of one CAN node in network wrong • CAN network not connected • hardware wiring of CAN bus not correct
Effect	Fault reaction defined in →Abort connection option code
Error recovery	Send NMT command reset communication

7.2.33 CAN heartbeat error

Error code	0x8130
Error register	0001 0000b
Cause	CANopen Heartbeat Consumer Procedure or Life Guarding have detected a timeout. Probably, the procedure has failed due to wrong configuration. Heartbeat Consumers will be disabled if →Consumer heartbeat time = 0
Effect	Fault reaction defined in →Abort connection option code
Error recovery	Send NMT command reset communication

7.2.34 CAN PDO COB-ID collision

Error code	0x8150
Error register	0001 0000b
Cause	Possibly, another CAN node has configured the same transmit PDO COB-ID. Device has received a bad transmit PDO request (valid COB-ID without RTR bit set).
Effect	Fault reaction defined in →Abort connection option code
Error recovery	Reset fault with →Controlword

7.2.35 EtherCAT communication error

Error code	0x8180
Error register	0001 0000b
Cause	EtherCAT communication error during operation enable (link lost)
Effect	Fault reaction defined in →Abort connection option code
Error recovery	Reset fault with →Controlword

7.2.36 EtherCAT initialization error

Error code	0x8181
Error register	0001 0000b
Cause	Initialization of the Ethernet module has failed
Effect	Device disabled Red LED "ON" Error flag set in →Statusword
Error recovery	Reset device. If the problem persists, perform firmware update or contact your supplier.

7.2.37 EtherCAT Rx queue overflow

Error code	0x8182
Error register	0001 0000b
Cause	The EtherCAT receive queue had an overrun caused by too high communication rate
Effect	Fault reaction defined in →Abort connection option code
Error recovery	Reset fault with →Controlword

7.2.38 EtherCAT communication error (internal)

Error code	0x8183
Error register	0001 0000b
Cause	Internal communication of the EtherCAT module has failed
Effect	Fault reaction defined in Abort connection option code
Error recovery	Reset fault with →Controlword

7.2.39 CAN bus turned off

Error code	0x81FD
Error register	0001 0000b
Cause	CAN controller has entered CAN bus off state
Effect	Fault reaction defined in →Abort connection option code
Error recovery	Reset fault with →Controlword

7.2.40 CAN Rx queue overflow

Error code	0x81FE
Error register	0001 0000b
Cause	One of the CAN receive queues had an overrun caused by too high communication rate
Effect	Fault reaction defined in →Abort connection option code
Error recovery	Reset fault with →Controlword

7.2.41 CAN Tx queue overflow

Error code	0x81FF
Error register	0001 0000b
Cause	One of the CAN transmit queues had an overrun caused by too high communication rate due to... <ul style="list-style-type: none"> • load on CAN bus too high • event-triggered PDOs defined with too small inhibit time • PDO communication configured too high (synchronous) for actual cycle time • CAN bus inactive but heartbeat producer enabled (→Producer heartbeat time)
Effect	Fault reaction defined in →Abort connection option code
Error recovery	Reset fault with →Controlword

7.2.42 CAN PDO length error

Error code	0x8210
Error register	0001 0000b
Cause	Received PDO was not processed due to length error (too short)
Effect	Fault reaction defined in →Abort connection option code
Error recovery	Reset fault with →Controlword

7.2.43 RPDO timeout

Error code	0x8250
Error register	0001 0000b
Cause	Interpolation aborted in cyclic mode due to no PDO received after elapsed interpolation time period. The error also occurs if the master aborts communication, e.g. due to timing violations of the synchronous PDO transfer.
Effect	Fault reaction defined in →Abort connection option code
Error recovery	Reset fault with →Controlword

7.2.44 EtherCAT PDO communication error

Error code	0x8280
Error register	0001 0000b
Cause	EtherCAT module detected an error at Process Data (PDO) communication
Effect	Fault reaction defined in →Abort connection option code
Error recovery	Reset fault with →Controlword

7.2.45 EtherCAT SDO communication error

Error code	0x8281
Error register	0001 0000b
Cause	EtherCAT module detected an error at Service Data (SDO) communication
Effect	Fault reaction defined in →Abort connection option code
Error recovery	Reset fault with →Controlword

7.2.46 Following error

Error code	0x8611
Error register	1000 0000b
Cause	Difference between →Position demand value and →Position actual value higher than →Following error window
Effect	Fault reaction defined in →Fault reaction option code
Error recovery	Reset fault with →Controlword

7.2.47 Negative limit switch error

Error code	0x8A80
Error register	1000 0000b
Cause	Negative limit switch was/is active. Wrong configuration of limit switch function in →Digital inputs.
Effect	Fault reaction defined in →Fault reaction option code
Error recovery	Reset fault with →Controlword

7.2.48 Positive limit switch error

Error code	0x8A81
Error register	1000 0000b
Cause	Positive limit switch was/is active. Wrong configuration of limit switch function in →Digital inputs.
Effect	Fault reaction defined in →Fault reaction option code
Error recovery	Reset fault with →Controlword

7.2.49 Software position limit error

Error code	0x8A82
Error register	1000 0000b
Cause	Movement commanded or actual position runs out of software position limit
Effect	Fault reaction defined in →Fault reaction option code
Error recovery	Reset fault with →Controlword

7.2.50 STO error

Error code	0x8A88
Error register	0000 0001b
Cause	Error when STO is not active. STO functionality was triggered while power stage was enabled.
Effect	Device disabled Red LED "ON" Error flag set in →Statusword
Error recovery	Reset fault with →Controlword

7.2.51 System overloaded error

Error code	0xFF01
Error register	0000 0001b
Cause	Device has not enough free resources to process new commands
Effect	Device disabled Red LED "ON" Error flag set in →Statusword
Error recovery	Reset fault with →Controlword

7.2.52 Watchdog error

Error code	0xFF02
Error register	0000 0001b
Cause	Cyclic monitoring has detected an invalid device status
Effect	Device disabled Red LED "ON" Error flag set in → Statusword
Error recovery	Reset fault with → Controlword

7.2.53 System peak overloaded error

Error code	0xFF0B
Error register	0000 0001b
Cause	The device has not enough free resources to provide proper regulation
Effect	Device disabled Red LED "ON" Error flag set in → Statusword
Error recovery	Reset fault with → Controlword

7.2.54 Controller gain error

Error code	0xFF10
Error register	0010 0000b
Cause	Control function not possible due to bad controller gains
Effect	Device disabled Red LED "ON" Error flag set in → Statusword Fault reaction defined in → Fault reaction option code
Error recovery	Reset fault with → Controlword

7.2.55 Auto tuning current limit error

Error code	0xFF12
Error register	0010 0000b
Cause	Current limit occurred during auto tuning identification
Effect	Device disabled Red LED "ON" Error flag set in → Statusword
Error recovery	Reset fault with → Controlword

7.2.56 Auto tuning identification current error

Error code	0xFF13
Error register	0010 0000b
Cause	Identification current could not be reached during auto tuning identification
Effect	Device disabled Red LED "ON" Error flag set in → Statusword
Error recovery	Reset fault with → Controlword

7.2.57 Auto tuning data sampling error

Error code	0xFF14
Error register	0010 0000b
Cause	Data sampling initialization has failed
Effect	Device disabled Red LED "ON" Error flag set in → Statusword
Error recovery	Reset fault with → Controlword

7.2.58 Auto tuning sample mismatch error

Error code	0xFF15
Error register	0010 0000b
Cause	Sample data mismatched during auto tuning identification
Effect	Device disabled Red LED "ON" Error flag set in → Statusword
Error recovery	Reset fault with → Controlword

7.2.59 Auto tuning parameter error

Error code	0xFF16
Error register	0010 0000b
Cause	Wrong parameter for auto tuning identification. Error during identification auto tuning process.
Effect	Device disabled Red LED "ON" Error flag set in → Statusword
Error recovery	Reset fault with → Controlword

7.2.60 Auto tuning amplitude mismatch error

Error code	0xFF17
Error register	0010 0000b
Cause	Nominal actual amplitude mismatch during auto tuning identification
Effect	Device disabled Red LED "ON" Error flag set in → Statusword
Error recovery	Reset fault with → Controlword

7.2.61 Auto tuning period length error

Error code	0xFF18
Error register	0010 0000b
Cause	Sample period length too long during auto tuning identification
Effect	Device disabled Red LED "ON" Error flag set in → Statusword
Error recovery	Reset fault with → Controlword

7.2.62 Auto tuning timeout error

Error code	0xFF19
Error register	0010 0000b
Cause	Auto tuning identification timeout. Termination requirements not met.
Effect	Device disabled Red LED "ON" Error flag set in → Statusword
Error recovery	Reset fault with → Controlword

7.2.63 Auto tuning standstill error

Error code	0xFF20
Error register	0010 0000b
Cause	Motor did not reach standstill during auto tuning. Make sure that the motor is not moving when starting the tuning process.
Effect	Device disabled Red LED "ON" Error flag set in → Statusword
Error recovery	Reset fault with → Controlword

7.2.64 Auto tuning torque invalid error

Error code	0xFF21
Error register	0010 0000b
Cause	Motor movement has been obstructed during tuning process. This might, for example, be caused by the motor being connected to a rigid gear. Ensure that the motor movement is not obstructed.
Effect	Device disabled Red LED "ON" Error flag set in → Statusword
Error recovery	Reset fault with → Controlword

7.3 CANopen Communication Errors (Abort Codes)

An abort object will be sent over the network instead of a response to a SDO request if the request has failed. The same abort code will be sent as part of the response to other transfer request (such as USB).

The following abort codes are defined by CANopen Communication Profile CiA 301. Codes greater 0x0F00 0000 are maxon-specific.

Abort code	Name	Cause
0x0000 0000	No abort	Communication successful
0x0503 0000	Toggle error	Toggle bit not alternated
0x0504 0000	SDO timeout	SDO protocol timed out
0x0504 0001	Command unknown	Command specifier unknown
0x0504 0004	CRC error	CRC check failed
0x0601 0000	Access error	Unsupported access to an object
0x0601 0001	Write only error	Read command to a write only object
0x0601 0002	Read only error	Write command to a read only object
0x0601 0003	Subindex can not be written	Subindex can not be written, subindex 0 must be "0" (zero) for write access
0x0602 0000	Object does not exist error	Last read or write command had wrong object index or subindex
0x0604 0041	PDO mapping error	Object is not mappable to the PDO
0x0604 0042	PDO length error	Number and length of objects to be mapped would exceed PDO length
0x0604 0043	General parameter error	General parameter incompatibility
0x0604 0047	General internal incompatibility error	General internal incompatibility in device
0x0606 0000	Hardware error	Access failed due to hardware error
0x0607 0010	Service parameter error	Data type does not match, length or service parameter do not match
0x0607 0013	Service parameter too short error	Data type does not match, length of service parameter too long
0x0609 0011	Subindex error	Last read or write command had wrong object subindex
0x0609 0030	Value range error	Value range of parameter exceeded
0x0800 0000	General error	General error
0x0800 0020	Transfer or store error	Data cannot be transferred or stored
0x0800 0022	Wrong device state error	Data cannot be transferred or stored to application because of present device state
0x0F00 FFBE	Password error	Password is incorrect
0x0F00 FFBF	Illegal command error	Command code is illegal (does not exist)
0x0F00 FFC0	Wrong NMT state error	Device is in wrong NMT state

Table 7-160 CANopen communication errors

7.4 EtherCAT FoE Error Codes

In the event of a communication error during a File over EtherCAT (FoE) transfer, the following error codes as defined in the ETG.1020 V1.2.0 EtherCAT Protocol Enhancements Specification (→[12]) will be used.

Error code	Name	Cause
0x8002	Access denied	Unsupported access to an object
0x8004	Illegal	Data cannot be transferred or stored to application due to present device state
0x8008	Bootstrap only	FoE download is supported in bootstrap state only
0x8009	Not bootstrap	The downloaded file is not accepted for firmware updates
0x800B	Program error	Firmware programming was aborted due to a general internal error
0x800C	Checksum wrong	The checksum of the downloaded file was wrong
0x800D	Firmware does not fit for hardware	The firmware file is incompatible to the device hardware
0x8011	Flash problem	The flash memory of the device could not be erased or programmed
0x8012	File incompatible	The firmware format is incompatible to the device

Table 7-161 EtherCAT FoE communication error codes

••page intentionally left blank••

8 Firmware Version History

8.1 Version Overview

Date [yyyy-mm]	Version		Application		Description
	Software	Hardware	#	Version	
2018-12	0150h	6050h, 6150h, 6350h, 6551h, 6552h, 6450h	0000h	0000h	New hardware, new features, bug fixing
2018-06	0140h	6050h, 6150h, 6350h, 6551h, 6552h, 6450h	0000h	0000h	New hardware, new features, bug fixing
2017-12	0130h	6050h, 6150h, 6350h, 6551h, 6552h	0000h	0000h	New hardware, new features, bug fixing
2017-06	0120h	6050h, 6150h, 6350h, 6551h, 6552h	0000h	0000h	New hardware, new features, bug fixing
2016-11	0110h	6050h, 6150h, 6551h, 6552h	0000h	0000h	New hardware, new features, bug fixing
2016-06	0100h	6551h, 6552h	0000h	0000h	Initial release

Table 8-162 Version overview

8.2 EPOS4_0150h_xxxxh_0000h_0000h_0000h (Release 2018-12)

Description		
Binary files	EPOS4 Module 24/1.5 EPOS4 Compact 24/1.5 CAN EPOS4 Compact 24/1.5 EtherCAT	EPOS4_0150h_6050h_0000h_0000h.bin
	EPOS4 Module 50/5 EPOS4 Compact 50/5 CAN EPOS4 Compact 50/5 EtherCAT	EPOS4_0150h_6150h_0000h_0000h.bin
	EPOS4 Module 50/8 EPOS4 Compact 50/8 CAN EPOS4 Compact 50/8 EtherCAT	EPOS4_0150h_6551h_0000h_0000h.bin
	EPOS4 Module 50/15 EPOS4 Compact 50/15 CAN EPOS4 Compact 50/15 EtherCAT	EPOS4_0150h_6552h_0000h_0000h.bin
	EPOS4 50/5	EPOS4_0150h_6350h_0000h_0000h.bin
	EPOS4 70/15	EPOS4_0150h_6450h_0000h_0000h.bin
Features	Introduction	EPOS4 Compact 24/1.5 EtherCAT EPOS4 Compact 50/5 EtherCAT
	Regulation	Dual loop control added
	Regulation tuning	Regulation tuning for dual loop control added
	EtherCAT interface	Firmware update via EtherCAT interface (FoE) added
	USB-to-CAN gateway	Firmware update via USB-to-CAN gateway added
	Communication	NMT commands for USB-to-CAN and RS232-to-CAN gateway added
	Analog outputs	General purpose functionality for analog outputs added
	Analog inputs	Adjustment objects for gain and offset added
Changes	Incremental encoder	Measuring of encoder speed enhanced by detection of time between consecutive sensor edges.
	Hall sensors	Measuring of sensor speed enhanced by detection of time between consecutive sensor edges.
	SI units	SI unit velocity extended by units 10^{-4} [rpm], 10^{-5} [rpm] and [μrpm]
	Regulation tuning	Current control loop tuning improved
	USB interface	USB communication stability during firmware update improved
	CAN PDO	CAN PDO communication performance improved
	Bugfix	Sporadic "CAN overrun error" caused by excessive NMT command traffic solved
	Bugfix	RS232 blocking at high communication rate solved
	Bugfix	PVM statusword: Target reached signalization corrected
	Bugfix	EtherCAT status LED signalization according to ETG specification corrected
Bugfix	General minor bug fixing and improvements	

Table 8-163 EPOS4_0150h_xxxxh_0000h_0000h_0000h

8.3 EPOS4_0140h_xxxxh_0000h_0000h_0000h (Release 2018-06)

Description		
Binary files	EPOS4 Module 24/1.5 EPOS4 Compact 24/1.5 CAN	EPOS4_0140h_6050h_0000h_0000h.bin
	EPOS4 Module 50/5 EPOS4 Compact 50/5 CAN	EPOS4_0140h_6150h_0000h_0000h.bin
	EPOS4 Module 50/8 EPOS4 Compact 50/8 CAN EPOS4 Compact 50/8 EtherCAT	EPOS4_0140h_6551h_0000h_0000h.bin
	EPOS4 Module 50/15 EPOS4 Compact 50/15 CAN EPOS4 Compact 50/15 EtherCAT	EPOS4_0140h_6552h_0000h_0000h.bin
	EPOS4 50/5	EPOS4_0140h_6350h_0000h_0000h.bin
	EPOS4 70/15	EPOS4_0140h_6450h_0000h_0000h.bin
Features	Introduction	EPOS4 Compact 50/8 EtherCAT EPOS4 Compact 50/15 EtherCAT EPOS4 70/15
	Communication	Firmware update via CAN interface added
	Incremental encoder 2	Support of second incremental encoder added
	Analog incremental encoder	Support of analog incremental encoders added
	Modes of operation	Cyclic Synchronous Velocity (CSV) added
	Gear	Support of systems with attached gear added

Continued on next page.

Description		
Changes	Power supply	Powering of device via USB only suppressed
	Homing	Homing mode extended by methods featuring "current threshold"
	Incremental encoder	Measuring of sensor speed enhanced by detection of encoder pulse time
	Sensor supervision	Sensor supervision extended for the case of different main and commutation sensors
	SI units	SI unit velocity extended by units drpm, crpm and mrpm
	Regulation tuning	Data type of object "Electrical resistance" adapted
	Motor protection	Objects "I2t level motor" and "I2t level controller" changed to PDO mappable
	Device description	Full device name added to EtherCAT slave information file (ESI)
	Software position limits	Software position limits are also activated in unreferenced state
	Trajectory generator	Stability of trajectory generator improved
	Hall sensors	Spike filtering improved
	Profile Position Mode	PPM controlword: Handling of new setpoint and halt flag deactivation improved
	Bugfix	PPM: Sporadic spikes on demand value when immediately commanding target values solved
	Bugfix	PPM statusword: Spikes on set point acknowledge bit signalization during state change to quick stop or halt command corrected
	Bugfix	PVM statusword: Spikes on speed bit signalization during state change to quick stop corrected
	Bugfix	CSP: Target position value interpolation improved
	Bugfix	Deadlock caused by domain object access via EtherCAT with wrong data size solved
	Bugfix	Sporadic "CAN Rx queue overflow error" with inactive CAN interface solved
Bugfix	Wrong CAN COB-IDs display during CAN bus initialization fixed	
Bugfix	General minor bug fixing and improvements	

Table 8-164 EPOS4_0140h_xxxxh_0000h_0000h_0000h

8.4 EPOS4_0130h_xxxxh_0000h_0000h_0000h (Release 2017-12)

Description		
Binary files	EPOS4 Module 24/1.5 EPOS4 Compact 24/1.5 CAN	EPOS4_0130h_6050h_0000h_0000h.bin
	EPOS4 Module 50/5 EPOS4 Compact 50/5 CAN	EPOS4_0130h_6150h_0000h_0000h.bin
	EPOS4 Module 50/8 EPOS4 Compact 50/8 CAN	EPOS4_0130h_6551h_0000h_0000h.bin
	EPOS4 Module 50/15 EPOS4 Compact 50/15 CAN	EPOS4_0130h_6552h_0000h_0000h.bin
	EPOS4 50/5	EPOS4_0130h_6350h_0000h_0000h.bin
Features	Introduction	EPOS4 EtherCAT extension
	Communication	EtherCAT communication (CoE) for EPOS4 accessories with EtherCAT extension added
	Modes of operation	Cyclic Synchronous Position (CSP) added
	Custom persistent memory	Object to store custom values added
Changes	Bugfix	Position controller: anti-windup behavior improved
	Bugfix	Analog inputs: Display of negative values corrected
	Bugfix	SSI encoder: Reading special bits fixed
	Bugfix	CAN gateway: Sporadic watchdog error fixed
	Bugfix	CAN: Automatic bit rate detection fixed
	Bugfix	Statusword: Internal limit signalization corrected
	Bugfix	CST statusword: Drive follows command signalization corrected
	Bugfix	General minor bug fixing and improvements

Table 8-165 EPOS4_0130h_xxxxh_0000h_0000h_0000h

8.5 EPOS4_0120h_xxxxh_0000h_0000h_0000h (Release 2017-06)

Description		
Binary files	EPOS4 Module 24/1.5 EPOS4 Compact 24/1.5 CAN	EPOS4_0120h_6050h_0000h_0000h.bin
	EPOS4 Module 50/5 EPOS4 Compact 50/5 CAN	EPOS4_0120h_6150h_0000h_0000h.bin
	EPOS4 Module 50/8 EPOS4 Compact 50/8 CAN	EPOS4_0120h_6551h_0000h_0000h.bin
	EPOS4 Module 50/15 EPOS4 Compact 50/15 CAN	EPOS4_0120h_6552h_0000h_0000h.bin
	EPOS4 50/5	EPOS4_0120h_6350h_0000h_0000h.bin
Features	Introduction	EPOS4 50/5
	SSI encoder	EC (BLDC) motor commutation by SSI absolute encoder only (without Hall sensors) added
	Digital I/Os	Digital input functionality «Drive enable» and «Quick stop» added
	Watchdog	Watchdog handling (including error signalization) added
Changes	CAN PDO	CAN PDO communication performance improved
	System monitoring	System performance monitoring (including error signalization) improved
	Bugfix	PVM statusword: Target reached signalization at velocity limitation corrected
	Bugfix	Mechanical tuning: Error handling at wrong torque constant detection improved

Table 8-166 EPOS4_0120h_xxxxh_0000h_0000h_0000h

8.6 EPOS4_0110h_xxxxh_0000h_0000h_0000h (Release 2016-11)

Description		
Binary files	EPOS4 Module 24/1.5 EPOS4 Compact 24/1.5 CAN	EPOS4_0120h_6050h_0000h_0000h.bin
	EPOS4 Module 50/5 EPOS4 Compact 50/5 CAN	EPOS4_0120h_6150h_0000h_0000h.bin
	EPOS4 Module 50/8 EPOS4 Compact 50/8 CAN	EPOS4_0120h_6551h_0000h_0000h.bin
	EPOS4 Module 50/15 EPOS4 Compact 50/15 CAN	EPOS4_0120h_6552h_0000h_0000h.bin
Features	Introduction	EPOS4 Module 24/1.5 EPOS4 Compact 24/1.5 CAN EPOS4 Module 50/5 EPOS4 Compact 50/5 CAN
	RS232 interface	RS232 communication interface added
	USB-to-CAN gateway	Basic USB-to-CAN gateway functionality (SDO communication only)
	RS232-to-CAN gateway	Basic RS232-to-CAN gateway functionality (SDO communication only)
	SSI encoder	Support of SSI absolute encoders added
	Holding brake	Autonomous control of a holding brake based on the device state added
	Software position limits	Software position limits functionality added
Changes	Digital I/Os	Default values of object "Digital input configuration" (0x3142) adapted
	CAN heartbeat	Stability of heartbeat consumer improved
	Regulation Tuning	Object "Electrical system parameters" (0x3002) added
	Device state machine	Behavior at enabling while actual velocity is not zero improved
		Standstill window functionality added to detect standstill condition of the axis
	USB interface	Sensor handling at USB bus powering improved
	Bugfix	Wrong resetting of communication parameters to default value after firmware update fixed
	Bugfix	Sporadic Hall angle detection errors during alignment solved
	Bugfix	CAN PDO configuration handling corrected
	Bugfix	Data recorder: sporadic wrong recording data due to time stamp overflow solved
Bugfix	Current offset calibration improved to prevent sporadic wrong current offset values	
Bugfix	Sporadic communication blockage during boot up eliminated	

Table 8-167 EPOS4_0110h_xxxxh_0000h_0000h_0000h

Firmware Version History

EPOS4_0100h_xxxxh_0000h_0000h (Release 2016-06)

8.7 EPOS4_0100h_xxxxh_0000h_0000h_0000h (Release 2016-06)

Description		
Binary files	EPOS4 Module 50/8 EPOS4 Compact 50/8 CAN	EPOS4_0100h_6551h_0000h_0000h.bin
	EPOS4 Module 50/15 EPOS4 Compact 50/15 CAN	EPOS4_0100h_6552h_0000h_0000h.bin
Features	Full range	Initial release

Table 8-168 EPOS4_0100h_xxxxh_0000h_0000h_0000h

LIST OF FIGURES

Figure 1-1 Documentation structure 7

Figure 2-2 Communication architecture 11

Figure 2-3 Device State Machine 13

Figure 3-4 Functional architecture 19

Figure 3-5 Profile Position Mode – Block diagram 21

Figure 3-6 Profile position trajectory 21

Figure 3-7 Profile Position Mode – Setpoint example 24

Figure 3-8 Profile Velocity Mode – Block diagram 25

Figure 3-9 Profile velocity trajectory – Linear ramp (trapezoidal profile) 25

Figure 3-10 Homing Mode – Block diagram 28

Figure 3-11 Homing trajectory – Linear ramp (trapezoidal profile) 28

Figure 3-12 Homing method 1 31

Figure 3-13 Homing method 2 31

Figure 3-14 Homing method 7 32

Figure 3-15 Homing method 11 32

Figure 3-16 Homing method 17 33

Figure 3-17 Homing method 18 33

Figure 3-18 Homing method 23 33

Figure 3-19 Homing method 27 34

Figure 3-20 Homing method 33 34

Figure 3-21 Homing method 34 34

Figure 3-22 Homing method 37 35

Figure 3-23 Homing method -1 35

Figure 3-24 Homing method -2 35

Figure 3-25 Homing method -3 36

Figure 3-26 Homing method -4 36

Figure 3-27 Cyclic Synchronous Position Mode – Overview 37

Figure 3-28 Cyclic Synchronous Position Mode – Block diagram 38

Figure 3-29 Cyclic Synchronous Velocity Mode – Overview 41

Figure 3-30 Cyclic Synchronous Velocity Mode – Block diagram 41

Figure 3-31 Cyclic Synchronous Torque Mode – Overview 44

Figure 3-32 Cyclic Synchronous Torque Mode – Block diagram 44

Figure 3-33 Position Control Function – Block diagram 47

Figure 3-34 Velocity Control Function – Block diagram 49

Figure 3-35 Current Control Function – Block diagram 51

Figure 3-36 Standardized peak current vs. standardized peak current time 53

Figure 3-37 Cyclic mode standardized vs. standardized “ON time” 54

Figure 4-38 Digital input functionality 55

Figure 4-39 Digital output functionality 56

Figure 4-40 Analog output functionality 57

Figure 6-41 SSI encoder – Data rate vs. cable length 155

Figure 6-42 SSI encoder – Data frame 156

Figure 6-43	SSI encoder – Timing	157
Figure 6-44	Block commutation of EC (BLDC) motors – Definition of phases	160
Figure 6-45	Standstill window	182
Figure 6-46	Holding brake activation timing (digital output polarity “High active”).	189

LIST OF TABLES

Table 1-1 Notations used 8

Table 1-2 Abbreviations & acronyms used 8

Table 1-3 Brand names and trademark owners 9

Table 1-4 Sources for additional information 10

Table 2-5 Device state bits 14

Table 2-6 Device state transitions. 15

Table 2-7 Axis control commands. 15

Table 2-8 User-defined units – Parameter structure 16

Table 2-9 SI units – Notation index. 16

Table 2-10 CiA 402 Application profile-specific units – Notation index. 16

Table 2-11 Unit prefixes – Notation index. 17

Table 3-12 Profile Position Mode – Configuration parameters 22

Table 3-13 Profile Position Mode – Commanding parameters 22

Table 3-14 Profile Position Mode – Controlword 23

Table 3-15 Profile Position Mode – Controlword bits 23

Table 3-16 Profile Position Mode – Output parameters 23

Table 3-17 Profile Position Mode – Statusword 24

Table 3-18 Profile Position Mode – Statusword bits 24

Table 3-19 Profile Velocity Mode – Configuration parameters 26

Table 3-20 Profile Velocity Mode – Commanding parameters 26

Table 3-21 Profile Velocity Mode – Controlword. 26

Table 3-22 Profile Velocity Mode – Controlword bits 26

Table 3-23 Profile Velocity Mode – Output parameters 27

Table 3-24 Profile Velocity Mode – Statusword 27

Table 3-25 Profile Velocity Mode – Statusword bits 27

Table 3-26 Homing Mode – Configuration parameters. 29

Table 3-27 Homing Mode – Commanding parameters. 29

Table 3-28 Homing Mode – Controlword 29

Table 3-29 Homing Mode – Controlword bits 29

Table 3-30 Homing Mode – Output parameters 29

Table 3-31 Homing Mode – Statusword 30

Table 3-32 Homing Mode – Statusword bit 15 30

Table 3-33 Homing Mode – Statusword bits 10, 12, and 13. 30

Table 3-34 Cyclic Synchronous Position Mode – Configuration parameters 39

Table 3-35 Cyclic Synchronous Position Mode – Commanding parameters 39

Table 3-36 Cyclic Synchronous Position Mode – Output parameters 40

Table 3-37 Cyclic Synchronous Position Mode – Statusword 40

Table 3-38 Cyclic Synchronous Position Mode – Statusword bits 40

Table 3-39 Cyclic Synchronous Velocity Mode – Configuration parameters 42

Table 3-40 Cyclic Synchronous Velocity Mode – Commanding parameters 42

Table 3-41 Cyclic Synchronous Velocity Mode – Output parameters. 42

Table 3-42 Cyclic Synchronous Velocity Mode – Statusword. 43

Table 3-43	Cyclic Synchronous Velocity Mode – Statusword bits	43
Table 3-44	Cyclic Synchronous Torque Mode – Configuration parameters	45
Table 3-45	Cyclic Synchronous Torque Mode – Commanding parameters	45
Table 3-46	Cyclic Synchronous Torque Mode – Output parameters	45
Table 3-47	Cyclic Synchronous Torque Mode – Statusword	46
Table 3-48	Cyclic Synchronous Torque Mode – Statusword bits	46
Table 3-49	Position Control Function – Configuration parameters	48
Table 3-50	Position Control Function – Output parameters	48
Table 3-51	Velocity Control Function – Configuration parameters	50
Table 3-52	Velocity Control Function – Output Parameters	50
Table 3-53	Current Control Function – Configuration parameters	52
Table 3-54	Current Control Function – Output parameters	52
Table 6-55	Object data types	61
Table 6-56	Object codes	61
Table 6-57	Object access types	61
Table 6-58	Object flags	62
Table 6-59	Object Dictionary (overview)	65
Table 6-60	Error register bits	66
Table 6-61	Store parameters signature	69
Table 6-62	Restore default parameters signature	70
Table 6-63	Consumer heartbeat time – Structure	72
Table 6-64	Definition of hardware version	74
Table 6-65	Newest acknowledged message – Read/Write bits	76
Table 6-66	Flags – Read/Write bits	77
Table 6-67	COB-ID used by RxPDO – Structure	79
Table 6-68	COB-ID used by RxPDO – Description	79
Table 6-69	Receive PDO mapping – Structure of mapped object	84
Table 6-70	Receive PDO 1 mapping	85
Table 6-71	Receive PDO 2 mapping	87
Table 6-72	Receive PDO 3 mapping	89
Table 6-73	Receive PDO 4 mapping	91
Table 6-74	COB-ID used by TxPDO – Structure	92
Table 6-75	COB-ID used by TxPDO – Description	92
Table 6-76	Transmit PDO mapping – Structure of mapped object	100
Table 6-77	Transmit PDO 1 mapping	101
Table 6-78	Transmit PDO 2 mapping	103
Table 6-79	Transmit PDO 3 mapping	105
Table 6-80	Transmit PDO 4 mapping	107
Table 6-81	SYNC mode output parameters	112
Table 6-82	Synchronization types supported – Output parameters	113
Table 6-83	SYNC mode input parameters	115
Table 6-84	Synchronization types supported – Input parameters	116
Table 6-85	Program control – Value range	119
Table 6-86	Program software identification – Value range	120
Table 6-87	Flash status identification – Value range	122

Table 6-88	CAN bit rate	124
Table 6-89	RS232 bit rate	125
Table 6-90	Fieldbus type	127
Table 6-91	Extension 1 hardware – Version definition	128
Table 6-92	Extension communication type	130
Table 6-93	Sensor configuration – Bits	132
Table 6-94	Supported sensor types	133
Table 6-95	Control structure – Bits	135
Table 6-96	Control structure without gear – permitted values	136
Table 6-97	Control structure with gear – permitted values	139
Table 6-98	Control structure without gear and dual loop control – permitted values	141
Table 6-99	Commutation sensors – Bits	142
Table 6-100	Commutation sensors – Value range	142
Table 6-101	Axis configuration miscellaneous – Bits	143
Table 6-102	Max system speed – Limits	144
Table 6-103	Max system speed – Speed limitations based on velocity units	144
Table 6-104	Nominal current	145
Table 6-105	Output current limit	146
Table 6-106	Gear velocity limits	150
Table 6-107	Gear miscellaneous configuration – Bits	150
Table 6-108	Digital incremental encoder 1 type – Bits	152
Table 6-109	Analog incremental encoder type – Bits	153
Table 6-110	Analog incremental encoder resolution – Bits	154
Table 6-111	SSI encoder – Number of data bits	156
Table 6-112	SSI encoder – Protocol	157
Table 6-113	Digital Hall sensor – Bits	161
Table 6-114	Digital Hall sensor – Pattern	162
Table 6-115	Digital incremental encoder 2 type – Bits	163
Table 6-116	Dual loop configuration miscellaneous – Bits	177
Table 6-117	Digital input bits	184
Table 6-118	Digital inputs – Default values	185
Table 6-119	Digital inputs – Configuration	186
Table 6-120	Digital output bits	187
Table 6-121	Digital outputs – Default values	188
Table 6-122	Digital outputs – Configuration	188
Table 6-123	Analog outputs – Default values	194
Table 6-124	Analog outputs – Configuration	194
Table 6-125	Abort connection option code	197
Table 6-126	Controlword bits	199
Table 6-127	Statusword bits	201
Table 6-128	Quick stop option code	201
Table 6-129	Shutdown option code	201
Table 6-130	Disable operation option code	202
Table 6-131	Fault reaction option code	202
Table 6-132	Modes of operation	203

Table 6-133	Max motor speed	210
Table 6-134	Motion profile types	212
Table 6-135	Homing methods	213
Table 6-136	SI units position – Bits	215
Table 6-137	SI units position – Value range	215
Table 6-138	SI units velocity – Bits	216
Table 6-139	SI units velocity – Value range	216
Table 6-140	SI units acceleration – Bits	217
Table 6-141	SI units acceleration – Value range	217
Table 6-142	Digital inputs	225
Table 6-143	Digital outputs	226
Table 6-144	Motor types	227
Table 6-145	Supported drive modes – Bits	228
Table 6-146	Configured module identification – Bits	231
Table 6-147	Configured module identification types	231
Table 6-148	MDP module PPM mapping – Default values for RxPDO	233
Table 6-149	MDP module PPM mapping – Default values for TxPDO	233
Table 6-150	MDP module PVM mapping – Default values for RxPDO	233
Table 6-151	MDP module PVM mapping – Default values for TxPDO	234
Table 6-152	MDP module CSP mapping – Default values for RxPDO	234
Table 6-153	MDP module CSP mapping – Default values for TxPDO	234
Table 6-154	MDP module CSV mapping – Default values for RxPDO	234
Table 6-155	MDP module CSV mapping – Default values for TxPDO	235
Table 6-156	MDP module CST mapping – Default values for RxPDO	235
Table 6-157	MDP module CST mapping – Default values for TxPDO	235
Table 7-158	Emergency message frame	237
Table 7-159	Device error codes	239
Table 7-160	CANopen communication errors	254
Table 7-161	EtherCAT FoE communication error codes	255
Table 8-162	Version overview	257
Table 8-163	EPOS4_0150h_xxxxh_0000h_0000h_0000h	258
Table 8-164	EPOS4_0140h_xxxxh_0000h_0000h_0000h	260
Table 8-165	EPOS4_0130h_xxxxh_0000h_0000h_0000h	261
Table 8-166	EPOS4_0120h_xxxxh_0000h_0000h_0000h	262
Table 8-167	EPOS4_0110h_xxxxh_0000h_0000h_0000h	263
Table 8-168	EPOS4_0100h_xxxxh_0000h_0000h_0000h	264

INDEX

Numerics

- 1st assigned RxPDO (object) **110**
- 1st assigned TxPDO (object) **111**
- 1st mapped object in RxPDO 1 (object) **85**
- 1st mapped object in RxPDO 2 (object) **87**
- 1st mapped object in RxPDO 3 (object) **89**
- 1st mapped object in RxPDO 4 (object) **91**
- 1st mapped object in TxPDO 1 (object) **101**
- 1st mapped object in TxPDO 2 (object) **103**
- 1st mapped object in TxPDO 3 (object) **105**
- 1st mapped object in TxPDO 4 (object) **107**

A

- abbreviations & acronyms **8**
- abort codes **254**
- Abort connection option code (object) **197**
- Access denied (error code) **255**
- Access error (abort code) **254**
- access types **61**
- Active fieldbus (object) **127**
- Additional identity (object) **127**
- Additional position actual values (object) **221**
- Additional velocity actual values (object) **222**
- Analog incremental encoder (object) **153**
- Analog incremental encoder index position (object) **154**
- Analog incremental encoder resolution (object) **154**
- Analog incremental encoder type (object) **153**
- Analog input 1...2 adjustment offset (object) **192**
- Analog input 1...2 voltage (object) **191**
- Analog input adjustment (object) **192**
- analog input functionality **56**
- Analog input properties (object) **191**
- Analog output 1...2 configuration (object) **194**
- Analog output 1...2 voltage (object) **193**
- analog output functionality **57**
- Analog output general purpose (object) **195**
- Analog output general purpose A...B (object) **195**
- Analog output properties (object) **193**
- applicable EU directive **10**
- Auto tuning amplitude mismatch error (error message) **252**
- Auto tuning current limit error (error message) **251**
- Auto tuning data sampling error (error message) **252**
- Auto tuning identification current error (error message) **251**
- Auto tuning parameter error (error message) **252**
- Auto tuning period length error (error message) **252**
- Auto tuning sample mismatch error (error message) **252**
- Auto tuning standstill error (error message) **253**
- Auto tuning timeout error (error message) **253**
- Auto tuning torque invalid error (error message) **253**
- Auxiliary loop FF acceleration gain (object) **175**
- Auxiliary loop FF velocity gain (object) **174**

- Auxiliary loop I gain (object) **174**
- Auxiliary loop observer friction (object) **176**
- Auxiliary loop observer inertia (object) **176**
- Auxiliary loop observer load correction gain (object) **176**
- Auxiliary loop observer position correction gain (object) **175**
- Auxiliary loop observer velocity correction gain (object) **175**
- Auxiliary loop P gain (object) **174**
- Axis configuration (object) **132**
- Axis configuration miscellaneous (object) **143**

B

- binary files **257**
- bit rate
 - CAN **124**
 - RS232 **125**
- Bootstrap only (error code) **255**

C

- Calc and copy time (object) **114, 117**
- CAN bit rate (object) **124**
- CAN bit rate display (object) **126**
- CAN bus turned off (error message) **248**
- CAN heartbeat error (error message) **247**
- CAN overrun error (error message) **246**
- CAN overrun error (object lost) (error message) **246**
- CAN passive mode error (error message) **247**
- CAN PDO COB-ID collision (error message) **247**
- CAN PDO length error (error message) **249**
- CAN Rx queue overflow (error message) **248**
- CAN Tx queue overflow (error message) **248**
- CANopen communication errors **254**
- Checksum wrong (error code) **255**
- COB-ID EMCY (object) **71**
- COB-ID SDO client to server (object) **78**
- COB-ID SDO server to client (object) **78**
- COB-ID SYNC (object) **68**
- COB-ID used by RxPDO 1 (object) **79**
- COB-ID used by RxPDO 2 (object) **81**
- COB-ID used by RxPDO 3 (object) **82**
- COB-ID used by RxPDO 4 (object) **83**
- COB-ID used by TxPDO 1 (object) **92**
- COB-ID used by TxPDO 2 (object) **94**
- COB-ID used by TxPDO 3 (object) **96**
- COB-ID used by TxPDO 4 (object) **98**
- Command unknown (abort code) **254**
- communication **59**
- Communication type SYNC channel 0 (object) **108**
- Communication type SYNC channel 1 (object) **108**
- Communication type SYNC channel 2 (object) **109**
- Communication type SYNC channel 3 (object) **109**
- Commutation sensors (object) **142**
- Configuration of analog outputs (object) **194**

Configuration of digital inputs (object) **185**
 Configuration of digital outputs (object) **188**
 Configured module ident list (object) **230**
 Consumer 1...2 heartbeat time (object) **72**
 Consumer heartbeat time (object) **72**
 Control structure (object) **134**
 Controller gain error (error message) **251**
 Controlword (object) **199**
 CRC error (abort code) **254**
 CST (Cyclic Synchronous Torque Mode) **44**
 CSV (Cyclic Synchronous Velocity Mode) **41**
 current (units) **16**
 Current actual value (object) **179**
 Current actual value averaged (object) **179**
 Current actual values (object) **179**
 Current control parameter set (object) **164**
 Current controller I gain (object) **164**
 Current controller P gain (object) **164**
 Current demand value (object) **178**
 Current threshold for homing mode (object) **178**
 Custom persistent memory (object) **130**
 Custom persistent memory 1...4 (object) **130**
 Cycle time (object) **112, 115**
 Cycle time too small (object) **114, 117**
 Cyclic Synchronous Position Mode (brief description) **20**
 Cyclic Synchronous Torque Mode (brief description) **20**
 Cyclic Synchronous Velocity Mode (brief description) **20**

D

Delay time (object) **114**
 Detected module ident list (object) **232**
 Device type (object) **66**
 Diagnosis history (object) **75**
 Diagnosis message (object) **77**
 Digital Hall sensor (object) **161**
 Digital Hall sensor pattern (object) **162**
 Digital Hall sensor type (object) **161**
 digital Hall sensors (types) **161**
 Digital incremental encoder 1 (object) **151**
 Digital incremental encoder 1 index position (object) **152**
 Digital incremental encoder 1 number of pulses (object) **151**
 Digital incremental encoder 1 type (object) **152**
 Digital incremental encoder 2 (object) **162**
 Digital incremental encoder 2 index position (object) **163**
 Digital incremental encoder 2 number of pulses (object) **162**
 Digital incremental encoder 2 type (object) **163**
 Digital input 1...4 configuration (object) **185**
 digital input functionality **55**
 Digital input properties (object) **184**
 Digital inputs (object) **225**
 Digital inputs logic state (object) **184**
 Digital inputs polarity (object) **184**
 Digital output 1...2 configuration (object) **188**
 digital output functionality **56**
 Digital output properties (object) **187**
 Digital outputs (object) **226**

Digital outputs logic state (object) **187**
 Digital outputs polarity (object) **187**
 dimensionless (units) **16**
 Disable operation option code (object) **202**
 Dual loop configuration miscellaneous (object) **177**
 Dual loop position control parameter set (object) **171**

E

electric current (units) **16**
 Electrical inductance (object) **148**
 Electrical resistance (object) **148**
 Electrical system parameters (object) **148**
 Error code (object) **198**
 Error history (object) **67**
 Error history 1...5 (object) **67**
 Error register (object) **66**
 errors
 communication **254**
 device **237**
 EtherCAT communication error (internal) (error message) **248**
 EtherCAT communication error (error message) **247**
 EtherCAT error codes **255**
 EtherCAT initialization error (error message) **247**
 EtherCAT PDO communication error (error message) **249**
 EtherCAT Rx queue overflow (error message) **248**
 EtherCAT SDO communication error (error message) **249**
 EU directive, applicable **10**
 Extension 1 application number (object) **129**
 Extension 1 application version (object) **129**
 Extension 1 hardware version (object) **128**
 Extension 1 identity (object) **128**
 Extension 1 serial number (object) **129**
 Extension 1 software version (object) **128**
 Extension 1 type (object) **130**
 Extension 1 watchdog error (error message) **243**

F

Fault reaction option code (object) **202**
 File incompatible (error code) **255**
 Firmware does not fit for hardware (error code) **255**
 Firmware incompatibility error (error message) **240**
 firmware versions **257**
 flags **62**
 Flags (object) **77**
 Flash problem (error code) **255**
 Flash status identification (object) **121**
 Following error (error message) **249**
 Following error actual value (object) **224**
 Following error timeout (object) **205**
 Following error window (object) **204**

G

gateway communication **59**
 Gear configuration (object) **149**
 Gear miscellaneous configuration (object) **150**
 Gear reduction denominator (object) **149**

Gear reduction numerator (object) **149**
gear, virtual **134**
General error (abort code) **254**
General internal incompatibility error (abort code) **254**
General parameter error (abort code) **254**
Generic error (error message) **239**
Generic initialization error (error message) **239**

H

Hall angle detection error (error message) **245**
Hall sensor (digital) **161**
Hall sensor error (error message) **245**
Hall sensor not found error (error message) **245**
Hall sensors (types) **161**
hardware binary files **257**
Hardware defect error (error message) **242**
Hardware error (abort code) **254**
Hardware error (error message) **242**
Hardware incompatibility error (error message) **242**
hardware versions **74**
High-speed digital input 1...4 configuration (object) **185**
High-speed digital output 1 configuration (object) **188**
HMM (Homing Mode) **28**
Holding brake fall time (object) **190**
Holding brake parameters (object) **189**
Holding brake rise time (object) **190**
Home offset move distance (object) **178**
Home position (object) **177**
Homing **28**
Homing acceleration (object) **215**
Homing method (object) **213**
Homing Mode (brief description) **20**
Homing speeds (object) **214**
how to
 decode abbreviations and acronyms **8**
 determine output current limitation **53**
 interpret icons and signs used in the document **9**
 use Current Control Function **52**
 use Cyclic Synchronous Torque Mode **39, 45**
 use Cyclic Synchronous Velocity Mode **42**
 use Homing Mode **29**
 use Position Control Function **48**
 use Profile Position Mode **22**
 use Profile Velocity Mode **26**
 use Velocity Control Function **50**

I

I2t level controller (object) **196**
I2t level motor (object) **196**
Identity object (object) **73**
Illegal (error code) **255**
Illegal command error (abort code) **254**
increments (units) **16**
Index distance (object) **229**
Inhibit time TxPDO 1 (object) **93**
Inhibit time TxPDO 2 (object) **95**
Inhibit time TxPDO 3 (object) **97**

Inhibit time TxPDO 4 (object) **99**
input functionality **55, 56**
Internal software error (error message) **243**
Interpolation time index (object) **219**
Interpolation time period (object) **219**
Interpolation time period value (object) **219**

L

length (units) **16**
Logic supply voltage too low error (error message) **241**

M

Main loop filter coefficient A (object) **172**
Main loop filter coefficient B (object) **172**
Main loop filter coefficient C (object) **173**
Main loop filter coefficient D (object) **173**
Main loop filter coefficient E (object) **173**
Main loop gain scheduling weight (object) **172**
Main loop P gain high bandwidth (object) **171**
Main loop P gain low bandwidth (object) **171**
Main sensor direction error (error message) **246**
Main sensor resolution (object) **143**
Manufacturer device name (object) **68**
mass (units) **16**
Max acceleration (object) **220**
Max gear input speed (object) **150**
Max motor speed (object) **210**
Max position limit (object) **209**
Max position range limit (object) **208**
Max profile velocity (object) **210**
Max system speed (object) **144**
Maximum messages (object) **75**
Maximum number of modules (object) **229**
Min position limit (object) **209**
Min position range limit (object) **208**
Minimum cycle time (object) **113, 116**
Missing commutation sensor error (error message) **246**
Missing main sensor error (error message) **246**
Modes of operation (object) **203**
Modes of operation display (object) **203**
modes, supported **20**
Modular device profile (object) **229**
Module 1, configured (object) **231**
Module 1, detected (object) **232**
Motion profile type (object) **212**
Motor data (object) **145**
Motor protection (object) **196**
Motor rated torque (object) **206**
motor speed **210**
Motor type (object) **227**
motor types, supported **10**

N

Nbr of configured modules (object) **230**
Nbr of detected modules (object) **232**
Negative limit switch error (error message) **250**

New messages available (object) **76**
 Newest acknowledged message (object) **76**
 Newest message (object) **76**
 No abort (abort code) **254**
 Node-ID (object) **123**
 Nominal current (object) **145**
 Not bootstrap (error code) **255**
 Number of assigned RxPDOs (object) **110**
 Number of assigned TxPDOs (object) **111**
 Number of errors (object) **67**
 Number of mapped objects in RxPDO 1 (object) **84**
 Number of mapped objects in RxPDO 2 (object) **86**
 Number of mapped objects in RxPDO 3 (object) **88**
 Number of mapped objects in RxPDO 4 (object) **90**
 Number of mapped objects in TxPDO 1 (object) **100**
 Number of mapped objects in TxPDO 2 (object) **102**
 Number of mapped objects in TxPDO 3 (object) **104**
 Number of mapped objects in TxPDO 4 (object) **106**
 Number of pole pairs (object) **146**
 Number of used SYNC manager channels (object) **108**

O

object codes **61**
 Object does not exist error (abort code) **254**
 object lost (see "CAN overrun error")
 object overview **62**
 operating license **10**
 Output current limit (object) **146**
 output functionality **56**
 Overcurrent error (error message) **240**
 overview (objects) **62**
 Overvoltage error (error message) **240**

P

Password error (abort code) **254**
 PDO length error (abort code) **254**
 PDO mapping error (abort code) **254**
 Persistent parameter corrupt error (error message) **243**
 Physical outputs (object) **226**
 Position actual value (object) **204**
 Position actual value sensor 1 (object) **221**
 Position actual value sensor 2 (object) **221**
 Position actual value sensor 3 (object) **221**
 Position control parameter set (object) **165**
 Position controller D gain (object) **166**
 Position controller FF acceleration gain (object) **166**
 Position controller FF velocity gain (object) **166**
 Position controller I gain (object) **165**
 Position controller P gain (object) **165**
 Position demand value (object) **204**
 Position offset (object) **217**
 Position range limit (object) **208**
 Position sensor breach error (error message) **244**
 Position sensor error (error message) **244**
 Position sensor index error (error message) **244**
 Position sensor resolution error (error message) **244**

Positive limit switch error (error message) **250**
 Power stage protection error (error message) **240**
 Power supply (object) **131**
 Power supply voltage (object) **131**
 PPM (Profile Position Mode) **21**
 prerequisites prior installation **10**
 Producer heartbeat time (object) **73**
 Product code (object) **74**
 Profile acceleration (object) **211**
 Profile deceleration (object) **211**
 Profile Position Mode (brief description) **20**
 Profile velocity (object) **211**
 Profile Velocity Mode (brief description) **20**
 Program control (object) **119**
 Program data (object) **118**
 Program error (error code) **255**
 Program number 1 (object)
 Flash status identification **121**
 Program control **119**
 Program data **118**
 Program software identification **120**
 Program software identification (object) **120**
 purpose of this document **7**
 PVM (Profile Velocity Mode) **25**

Q

Quick stop deceleration (object) **212**
 Quick stop option code (object) **201**

R

Read only error (abort code) **254**
 Receive PDO 1 mapping (object) **84**
 Receive PDO 1 parameter (object) **79**
 Receive PDO 2 mapping (object) **86**
 Receive PDO 2 parameter (object) **81**
 Receive PDO 3 mapping (object) **88**
 Receive PDO 3 parameter (object) **82**
 Receive PDO 4 mapping (object) **90**
 Receive PDO 4 parameter (object) **83**
 reference point (see "Homing")
 Restore all default parameters (object) **70**
 Restore default parameters (object) **70**
 Revision number (object) **74**
 revolutions (units) **16**
 RPDO timeout (error message) **249**
 RS232 bit rate (object) **125**
 RS232 frame timeout (object) **125**
 RS232-to-CAN gateway **60**

S

Save all parameters (object) **69**
 SDO server parameter (object) **78**
 SDO timeout (abort code) **254**
 sensor types **133**
 Sensors configuration (object) **132**
 Serial number (object) **75**

Serial number complete (object) **127**
 Service parameter error (abort code) **254**
 Service parameter too short error (abort code) **254**
 Shutdown option code (object) **201**
 SI unit acceleration (object) **217**
 SI unit position (object) **215**
 SI unit velocity (object) **216**
 Sign of life error (error message) **242**
 signs used **9**
 Software parameter error (error message) **243**
 Software position limit (object) **209**
 Software position limit error (error message) **250**
 Speed for switch search (object) **214**
 Speed for zero search (object) **214**
 SSI absolute encoder (object) **155**
 SSI commutation offset value (object) **159**
 SSI data rate (object) **155**
 SSI encoding type (object) **157**
 SSI number of data bits (object) **156**
 SSI position raw value (object) **159**
 SSI power up time (object) **158**
 SSI refresh frequency (object) **158**
 SSI sensor error (error message) **245**
 SSI special bits data (object) **158**
 SSI timeout time (object) **157**
 Standstill window (object) **183**
 Standstill window configuration (object) **182**
 Standstill window time (object) **183**
 Standstill window timeout (object) **183**
 Statusword (object) **200**
 steps (units) **16**
 STO error (error message) **250**
 Store parameters (object) **69**
 Subindex can not be written (abort code) **254**
 Subindex error (abort code) **254**
 Supported drive modes (object) **228**
 supported modes **20**
 symbols used **9**
 SYNC manager 2 parameter (object) **112**
 SYNC manager 2 PDO assignment (object) **110**
 SYNC manager 3 parameter (object) **115**
 SYNC manager 3 PDO assignment (object) **111**
 SYNC manager communication type (object) **108**
 Synchronization type (object) **112, 115**
 Synchronization types supported, input (object) **116**
 Synchronization types supported, output (object) **113**
 System overloaded error (error message) **250**
 System peak overloaded error (error message) **251**

T

Target position (object) **207**
 Target torque (object) **206**
 Target velocity (object) **227**
 Temperature power stage (object) **197**
 Thermal controller protection (object) **197**
 Thermal motor overload error (error message) **241**

Thermal overload error (error message) **241**
 Thermal time constant winding (object) **147**
 time (units) **16**
 Toggle error (abort code) **254**
 Torque actual value (object) **206**
 Torque actual value averaged (object) **180**
 Torque actual values (object) **180**
 Torque constant (object) **147**
 Torque offset (object) **218**
 trajectory generator
 Homing **28**
 Profile Position **21**
 Profile Velocity **25**
 Transfer or store error (abort code) **254**
 Transmission type RxPDO 1 (object) **80**
 Transmission type RxPDO 2 (object) **81**
 Transmission type RxPDO 3 (object) **82**
 Transmission type RxPDO 4 (object) **83**
 Transmission type TxPDO 1 (object) **93**
 Transmission type TxPDO 2 (object) **94**
 Transmission type TxPDO 3 (object) **96**
 Transmission type TxPDO 4 (object) **98**
 Transmit PDO 1 mapping (object) **100**
 Transmit PDO 1 parameter (object) **92**
 Transmit PDO 2 mapping (object) **102**
 Transmit PDO 2 parameter (object) **94**
 Transmit PDO 3 mapping (object) **104**
 Transmit PDO 3 parameter (object) **96**
 Transmit PDO 4 mapping (object) **106**
 Transmit PDO 4 parameter (object) **98**

U

Undervoltage error (error message) **241**
 units (definition of) **16**
 USB frame timeout (object) **126**
 USB-to-CAN gateway **60**

V

Value range error (abort code) **254**
 Velocity actual value (object) **205**
 Velocity actual value averaged (object) **181**
 Velocity actual value averaged sensor 1 (object) **223**
 Velocity actual value averaged sensor 2 (object) **223**
 Velocity actual value averaged sensor 3 (object) **223**
 Velocity actual value sensor 1 (object) **222**
 Velocity actual value sensor 2 (object) **222**
 Velocity actual value sensor 3 (object) **223**
 Velocity actual values (object) **181**
 Velocity control parameter set (object) **167**
 Velocity controller FF acceleration gain (object) **168**
 Velocity controller FF velocity gain (object) **168**
 Velocity controller I gain (object) **167**
 Velocity controller P gain (object) **167**
 Velocity demand value (object) **205**
 Velocity observer friction (object) **170**
 Velocity observer inertia (object) **170**

Velocity observer load correction gain (object) **170**
Velocity observer parameter set (object) **169**
Velocity observer position correction gain (object) **169**
Velocity observer velocity correction gain (object) **169**
Velocity offset (object) **218**
Vendor-ID (object) **73**
version history **257**
virtual gear **134**

W

Watchdog error (error message) **251**
Write only error (abort code) **254**
Wrong device state error (abort code) **254**
Wrong NMT state error (abort code) **254**

Z

zero point (see “Homing”)

••page intentionally left blank••



EtherCAT® is a registered trademark and patented technology, licensed by Beckhoff Automation GmbH, Germany

© 2018 maxon motor. All rights reserved.

The present document – including all parts thereof – is protected by copyright. Any use (including reproduction, translation, microfilming and other means of electronic data processing) beyond the narrow restrictions of the copyright law without the prior approval of maxon motor ag, is not permitted and subject to persecution under the applicable law.

maxon motor ag
Brünigstrasse 220
P.O.Box 263
CH-6072 Sachseln
Switzerland

Phone +41 41 666 15 00

Fax +41 41 666 16 50

www.maxonmotor.com